



A brand of **legrand**

2019

EDITION 2

RETAIL CATALOGUE



QUALITY, SAFETY AND RELIABILITY IN EVERYDAY ELECTRICAL PRODUCTS

The HPM Promise

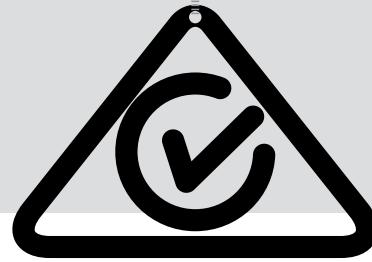

APPROVED TO AUSTRALIAN STANDARDS

Lighting and sensors



P. 31
LED
Downlights



P. 32
LED
Floodlights

Switches and sockets

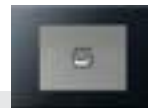

P. 57
Arteor



P. 61
Linea

General wiring accessories



P. 85
Clips and
brackets



P. 86
Junction
boxes

Powerboards



P. 95
Standard



P. 95
Switched

Extension leads



P. 101
Household



P. 102
Heavy duty

USB chargers, timers and adaptors



P. 107
USB chargers



P. 107
Plug-in analogue
timers

Door chimes



P. 113
Battery operated



P. 113
Plug-in

Ventilation



P. 117
Exhaust fans



P. 117
Exhaust fans



For more information visit
www.hpm.com.au
www.hpm.co.nz

MADE IN AUSTRALIA*



P. 33
LED
Lamps



P. 48
Lighting
accessories



P. 50
Motion
sensors



P. 52
Garden
lighting



P. 67
Vivo



P. 72
Excel



P. 75
Mechanisms



P. 80
Aqua
weatherproof



P. 86
Insulated &
earth connectors



P. 87
Insulated &
earth connectors



P. 88
Plug tops
and bases



P. 91
Plug-in MCBs



P. 95
USB chargers



P. 95
TV/AV



P. 86
Child-safe



P. 86
Powercentre



P. 102
Caravan
leads



P. 102
Construction
leads



P. 103
Accessories



P. 103
Cable
reels



P. 108
Plug-in digital
timers



P. 108
International
adaptors



P. 108
Adaptors



P. 108
Fuse wire



P. 113
Portable



P. 113
Piggyback
adjustable volume



P. 113
Eliot connected
doorbell



P. 113
Piggyback



P. 118
Exhaust fan
accessories



P. 119
Bathroom
heaters



P. 120
Ceiling sweep
fans



P. 121
Ceiling sweep
fan accessories

How to use this catalogue

Welcome to Edition 2 for 2019 of the HPM Retail Catalogue. This catalogue provides an overview of the wide range of products we offer that are designed to support your business, and has been divided in sections for quick and easy navigation.

Table of contents



Provides an outline of content in each section. The coloured bars correspond to the colour of each catalogue section for easy navigation.

Alphabetical index

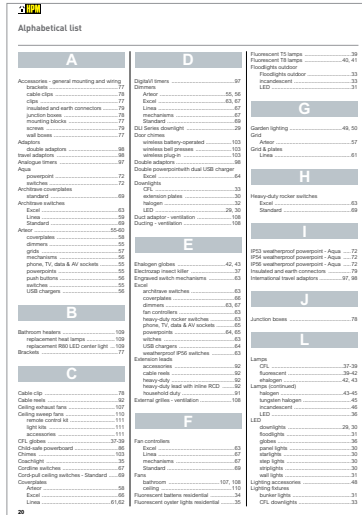

Contains a list of alphabetically listed general descriptions to find products easily.

Alphanumeric index

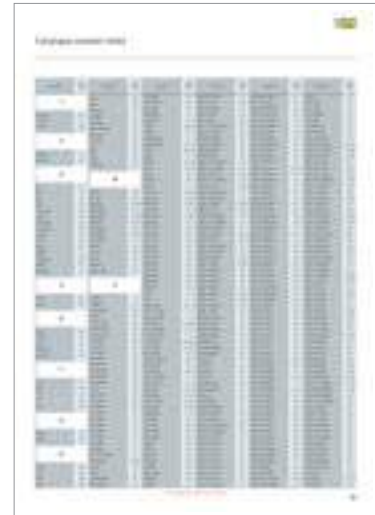

Contains an alphanumeric list of catalogue numbers, page numbers and quantities. The indexes start with numeric catalogue numbers then proceed to catalogue numbers with letters.

Packaging information



Contains information relating to product packaging along with examples.

Section index



Found at the beginning of each section to provide a breakdown of product categories with page numbers.

Technical references



Contains technical information, specifications and drawings on selected products.

How to use this catalogue

Content pages

Image with catalogue number for easy identification

Packaging type (see p.4)

Product barcode

Product quantity per individual box

Product inner box quantity

Product quantity per carton

Lighting and sensors
LED fixtures

CODE	Indoor	PK	PACKAGE	Height	Watt	Output
Integrated driver LED dimmable downlights						
Selectable colour temperature integrated driver LED dimmable downlights						
DU3018W	7W DU 690 790 890 in warm/cool/natural 2000-4000-5000K white 30mm cut-out dim			DX	9029006463753	1 - 24
DU1818W	7W DU 690 790 890 in warm/cool/natural 2000-4000-5000K white 100mm cut-out dim			DX	9029006463743	1 - 24
DU1817W	10W DU 1000 1300 1300 in warm/cool/natural 2000-4000-5000K white 100mm cut-out dim			DX	9029006463757	1 - 24
Tilt decorative - integrated driver LED dimmable downlights						
DU1000TILTNE	7W DU 700 in 80 decorative warm white 3000K chrome 30mm cut-out dim			DX	9029001486584	1 - 24
DU1600TILTNE	7W DU 820 in 80 decorative cool white 3000K chrome 30mm cut-out dim			DX	9029001486591	1 - 24
35mm diameter cut-out						
DU7001	5W DU 505 in warm white 3000K white 70mm cut-out dim			DX	9029001485704	1 - 48
DU7000	5W DU 505 in cool white 4000K white 70mm cut-out dim			DX	9029001485741	1 - 48
DU7001	5W DU 505 in warm white 3000K brushed chrome 70mm cut-out dim			DX	9029001485643	1 - 48
DU7001	5W DU 505 in cool white 4000K brushed chrome 70mm cut-out dim			DX	9029001485508	1 - 48
DU7000L	5W DU 505 in warm white 3000K black 70mm cut-out dim			DX	9029001481275	1 - 48
DU7000L	5W DU 505 in cool white 4000K black 70mm cut-out dim			DX	9029001481284	1 - 48

Catalogue number

Product description

Information icons

Information icons

The following icons appear adjacent to the product descriptions to highlight information about a particular product

- New product** Exciting new additions to our wide range of products.
- Energy Saving products** The HPM team has identified these products as possibly contributing to energy savings.
- More info available** More information available in the Technical section.
- Coming soon** Exciting new products that will be added to the range after this catalogue is printed.
- Product to be discontinued** Advanced information that the product will be discontinued in the near future.
- New Zealand** Product only available in New Zealand.
- Customer Special Order** Lines special orders as trade pack
- IC-4/F** **Insulation Rating** Insulation may abut or cover the LED luminaire

Packaging information

Guide

Cat.Nos **LED dimmable downlights with integrated driver**

DLI7001 5W warm white 3000k white 70mm cut-out dim

DLI7002 5W cool white 4000k white 70mm cut-out dim

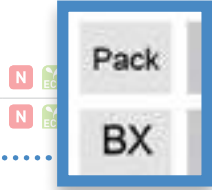

Barcode	Single qty	Inner qty	Outer qty
1001455134	1	-	48
1001455141	1	-	48

HANGSELL PACKAGING

CS

Clam Shell



BL

Blister Pack

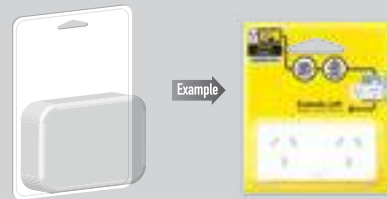

HBG

Hang Sell Tag



TG

Hang Sell Bag

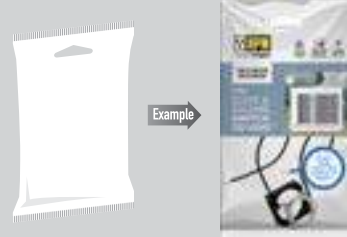

HSL

Hang Sell Sleeve

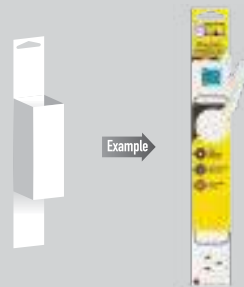

HBX

Hang Sell Box

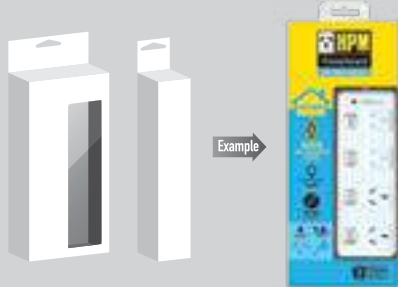

SHELF PACKAGING

BX

Box

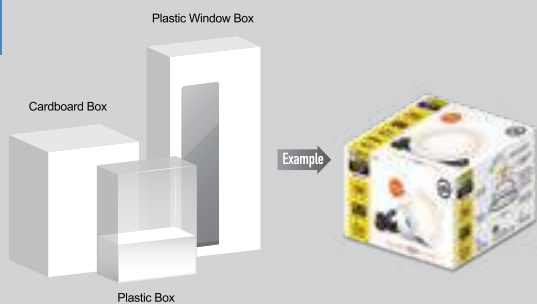

SL

Sleeve

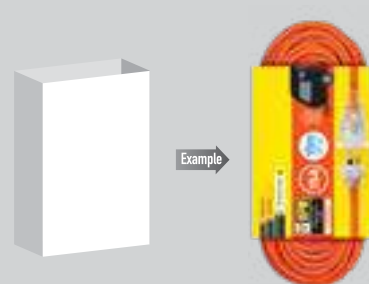

Alphabetical list

A

Accessories - general mounting and wiring	
brackets	71
cable clips	72
cable ties	73
clips	71
insulated and earth connectors	73
junction boxes	72
mounting blocks	71
screws	73
wall boxes	71
Adaptors	
double adaptors	94
travel adaptors	94
Analogue timers	93
Aqua	
powerpoint	67
switches	67
Architrave switches	
Excel	58
Linea	47
Standard	63
Arteor	43-46
coverplates	46
dimmers	43
grids	45
mechanisms	45
phone, TV, data & AV sockets	44
powerpoints	44
push buttons	45
switches	43
USB chargers	45

B

Bathroom heaters	105
replacement heat lamps	105
replacement R80 LED center light	105
Brackets	71

C

Cable clip	72
Cable reels	89
Ceiling exhaust fans	103
Ceiling sweep fans	106
remote control kit	107
light kits	107
accessories	107
CFL globes	25-27
Child-safe powerboard	82
Chimes	99
Coachlight	23
Como	65
powerpoints	65
switches	65
Cordline switches	61
Cord-pull ceiling switches - Standard	63
Coverplates	
Arteor	46
Excel	60
Linea	49,52
Vivo	57

D

Digital timers	94
Dimmers	
Arteor	43, 45
Excel	58, 61
Linea	47
Standard	63
Vivo	54
DLI Series downlight	15
Door chimes	
wireless battery-operated	99
wireless bell presses	99
wireless plug-in	99
Double adaptors	94
Double powerpoint with dual USB charger	
Excel	59
Downlights	
CFL	21
extension plates	17
halogen	21
LED	15, 17
Duct adaptor - ventilation	104
Ducting - ventilation	104

E

Ehalogen globes	30, 31
Electrozap insect killer	25
Engraved switch mechanisms	58
Excel	
architrave switches	58
coverplates	60
dimmers	58, 61
fan controllers	58
rocker switches	58
phone, TV, data & AV sockets	59
powerpoints	59
switches	58
USB chargers	59
weatherproof IP56 switches	58
Extension leads	
accessories	89
cable reels	89
heavy-duty	88
heavy-duty lead with inline RCD	88
household duty	87
External grilles - ventilation	104

F

Fan controllers	
Excel	58
Linea	47
mechanisms	61
Standard	63
Vivo	54
Fans	
bathroom	103, 104
ceiling	106
Fluorescent battens residential	23
Fluorescent oyster lights residential	23
Fluorescent T5 lamps	27
Fluorescent T8 lamps	27, 29
Floodlights outdoor	
incandescent	21
LED	20

G

Garden lighting	38, 39
Grid	
Arteor	45
Vivo	56
Grid & plates	
Linea	48

H

Heavy-duty rocker switches	
Excel	58
Standard	63

I

IP53 weatherproof powerpoint - Aqua	66
IP54 weatherproof powerpoint - Aqua	66
IP56 weatherproof powerpoint - Aqua	66
Insulated and earth connectors	73
International travel adaptors	94

J

Junction boxes	72
----------------	----

L

Lamps	
CFL	25-27
fluorescent	27-29
ehalogen	30, 31
halogen	31-33
tungsten halogen	33
incandescent	33
LED	
deck	19
downlights	15, 17
floodlights	20
globes	24-25
panel lights	17
starlights	18
step lights	18
striplights	18
wall lights	19
Lighting accessories	35
Lighting fixtures	
bunker lights	19
CFL downlights	21
downlights extension plates	17
fluorescent battens	23
fluorescent oyster lights	23
halogen downlights	21
halogen floodlights	22
incandescent floodlights	22
LED downlights	15, 17
LED floodlights	20

Alphabetical list

LED panel lights	17
LED starlights	18
LED step lights	18
LED striplights	18
LED wall lights	18
T5 Fluorescent battens	23
T8 Fluorescent battens	23

Linea	
accessories	71
coverplates	49-52
powerpoints	48
switches	47
dimmers	47
fan controllers	47
grid & plates	48
mounting brackets	71
powerpoints	48
switches – architrave	47
switches	47
wall boxes	71

M

MCBs	
plug-in	77
mini circuit	77

Mechanisms	
Arteor	45
Excel/Linea	
cordline switches	61
dimmers	61
fan controllers	61
fan knobs	61
phone, TV, data and AV sockets	62
switches	61
USB chargers	62

Mounting accessories	
Linea	71

Movement sensors	
IP44 Sensors	36
IP66 Sensors	36
MR16 LED retrofit downlights	17

N

Night light	35
-------------------	----

O

Oyster lights	
residential	18

P

Phone, TV, data and AV sockets	
Arteor	44
Excel	59, 62
Linea	48, 62
Standard	64
Vivo	55
Plug-in MCB's	77

Plug-in timers	
analogue outdoor timers	93
analogue timers	93
digital timers	94
Plug bases	74
Plug tops	74
Plugboss heavy-duty	82
Portable USB Chargers	93

Powerboards	
child-safe	82
individual switched outlets	81
master switch	81
Plugboss heavy-duty	82
power adaptor	82
TV & AV	81
USB chargers	81
worksite portable powercentre	82

Powerpoints	
Arteor	44
Aqua	67
Como	65
Excel	59
Linea	48
Standard	64
Vivo	54-55
Push buttons	
Arteor	45

R

Rotary dimmers	
Arteor	45
Excel	58, 61
Linea	47, 61
mechanisms	61
Standard	63
Vivo	54

S

Safety plugs	75
Sensors	
IP44 movement sensors	36
IP66 movement sensors	36

Standard	
architrave	63
coverplates	64
dimmers	63
fan controllers	63
phone, TV, data and AV sockets	64
powerpoints	64
switches	63

Switches	
Arteor	43
Aqua	67
Como	65
Excel	58
Linea	47
Standard	63
Vivo	53

T

T5 fluorescent battens	27
T8 fluorescent battens	27-29
Timers	

plug-in analogue outdoor timers	93
plug-in analogue timers	93
plug-in digital timers	94
Travel adaptors	94

U

USB chargers	
Arteor	45
Excel	59
mechanisms	62
powerboards	81
powerpoints	45, 59, 55
portable USB chargers	93
USB travel chargers	93
Vivo	55

V

Ventilation	
bathroom heaters	105
replacement heat lamps	105
replacement LED centre light	105
ceiling exhaust fans	103
ceiling sweep fans	106
ceiling sweep fans accessories	107
ceiling sweep fans light kits	107
ceiling sweep fans remote control kit	107
duct adaptor	104
ducting	104
exhaust fans	103, 104
external grilles	104
time delay module	104
wall exhaust fans	103
wall kits	104
window kits	104

Vivo	
advanced functions	56
grids	56
coverplates	57
powerpoints	54-55
switches	53
phone, TV, data and AV outlets	55
mechanisms	57

W

Wall boxes	71
Wall exhaust fans	103
Wall kits – ventilation	104
Weatherproof IP56 switches – Aqua	67
Weatherproof IP56 switches – Excel	58

Conditions of sale

In accordance with its policy of continuous improvement the Company reserves the right to change specifications and designs without notice. All illustrations, descriptions, dimensions and weights in this catalogue are for guidance and cannot be held binding on the Company.

Catalogue number index

Cat. Nos	Page No	Cat. Nos	Page No	Cat. Nos	Page No	Cat. Nos	Page No	Cat. Nos	Page No
1		BH2NDWE	105	CD405	72	CDA770/1WE	63	CDCM920/2HWE	65
106/1BL	74	BH4DWE	105	CD406	72	CDA770/2PLWE	64	CDF1036/3WE	63
137/1WE	71	BH4NDMS	105	CD413	72	CDA770/2WE	63	CDFLUSHCAPS	64
2		BH4NDWE	105	CD420/18	62	CDA770/3WE	63	CDGLCC4	39
2WS38	66	BU140WE	71	CD429	71	CDAL770/12HWSWE	63	CDKNOB1WE	47
2WS38P	66	BU366LYWE	34	CD555104	89	CDAL770/12WE	63	CDLN450PWEWE	47
3		BU37CL	74	CD555124	89	CDAR400TMMGN	45	CDLN770/1BLBL	47
310/10WE	35	BU37QC	74	CD575430	46	CDAR400TMWE	45	CDLN770/1BLGL	47
333BL	35	BU401/1	73	CD575431	46	CDAR450PMGN	43	CDLN770/1CXWEWE	48
359/10WE	35	BU404	72	CD575432	46	CDAR450PMMGN	45	CDLN770/1GPLWE	48
360/W1WE	34	BU429R	71	CD575433	46	CDAR450PMWE	45	CDLN770/1PLAS	49
361LS	35	BUEV770/1WE	53	CD575434	46	CDAR450PWE	43	CDLN770/1PLAU	50
366BL	34	BUXL777WE	59	CD575435	46	CDAR770/1GOMGN	45	CDLN770/1PLBL	49
366BR	34	C		CD575436	46	CDAR770/1GOWE	45	CDLN770/1PLGL	49
366LYWE	34	C239WE	71	CD576470	46	CDAR770/1MGN	43	CDLN770/1PLKH	49
366WE	34	CD100/8WE	74	CD576471	46	CDAR770/1RJ5EWE	44	CDLN770/1PLMS	49
366YWE	34	CD1002	75	CD576472	46	CDAR770/1WE	43	CDLN770/1PLOL	49
381	34	CD100L15CL	74	CD576475	46	CDAR770/2GOMGN	45	CDLN770/1PLPI	50
388	34	CD100L15GY	74	CD576476	46	CDAR770/2GOWE	45	CDLN770/1PLSB	50
390	34	CD100L15WE	74	CD576478	46	CDAR770/2MGN	43	CDLN770/1PLWE	49
5		CD100LBL	74	CD576479	46	CDAR770/2WE	43	CDLN770/1PLYE	49
57434	75	CD100LCL	74	CD600WE	63	CDAR770/3FLHMGN	43	CDLN770/1RJ2WE	48
57514	75	CD100LGY	74	CD601WE	63	CDAR770/3FLHWE	43	CDLN770/1WEWS	47
6		CD100LWE	74	CD65WE	63	CDAR770/3GOMGN	45	CDLN770/1WEWE	47
630/3	36	CD106/1GY	74	CD711	71	CDAR770/3GOWE	45	CDLN770/2BLBL	47
630/3A	36	CD106/1WE	74	CD712	71	CDAR770/3MGN	43	CDLN770/2BLGL	47
630/3ABL	36	CD106/2WE	74	CD770/0WE	64	CDAR770/3WE	43	CDLN770/2GPLWE	48
630/9-3W	36	CD106/3WE	74	CD770/1CXWE	64	CDAR770/4FLHMGN	43	CDLN770/2PLAS	50
630R01WE	36	CD107	89	CD770/1PLWE	64	CDAR770/4FLHWE	43	CDLN770/2PLAU	50
630R02WE	36	CD1210S2	62	CD770/1WE	63	CDAR770/4GOMGN	45	CDLN770/2PLBL	50
630S01BL	36	CD1210S4	62	CD770/2PCWE	58	CDAR770/4GOWE	45	CDLN770/2PLGL	50
630S01WE	36	CD1310FS	62	CD770/2PLWE	64	CDAR770/4MGN	43	CDLN770/2PLKH	50
630S02WE	36	CD137WE	71	CD770/2WE	63	CDAR770/4WE	43	CDLN770/2PLMS	50
630SM01BL	36	CD140WE	71	CD770/3WE	63	CDAR770MMGN	44	CDLN770/2PLOL	50
630SM01WE	36	CD143	71	CD770/4WE	63	CDAR770MWE	44	CDLN770/2PLPI	50
8		CD143/2	71	CD770CMWE	62	CDAR777AMGN	44	CDLN770/2PLSB	50
80WE	35	CD150WE	71	CD770MBL	61	CDAR777AWE	44	CDLN770/2PLWE	50
84WE	35	CD156WE	71	CD770MWE	61	CDAR777MGN	44	CDLN770/2PLYE	50
A		CD1A770CXWE	64	CD770TOPLWE	64	CDAR777WE	44	CDLN770/2WEWS	47
A100	104	CD200LWE	63	CD777/15WE	64	CDAR777XMGN	44	CDLN770/2WEWE	47
A101	104	CD246	73	CD777WE	64	CDAR777XWE	44	CDLN770/3BLBL	47
A505	104	CD247	73	CD777XWE	64	CDAR787MGN	44	CDLN770/3PLAS	47
A800	104	CD300FMWE	47	CD787/15WE	64	CDAR787WE	44	CDLN770/3PLAU	47
AJ218HT	23	CD300FWE	47	CD787WE	64	CDAR870/1MGN	43	CDLN770/3PLGL	47
AJ236HT	23	CD310WE	35	CD787XWE	64	CDAR870/1WE	43	CDLN770/3PLKH	47
AR400A2PMMGN	45	CD333SKWE	35	CD790WE	64	CDAR870MMGN	44	CDLN770/3PLMS	47
AR400A2PMWE	45	CD333WE	35	CD7P15CL	75	CDAR870MWE	44	CDLN770/3PLOL	50
AR400A3PMMGN	45	CD366SWE	34	CD7P15GY	75	CDAR883/1MGN	43	CDLN770/3PLPI	50
AR400A3PMWE	45	CD366WE	34	CD7P15WE	74	CDAR883/1WE	43	CDLN770/3PLSB	50
AR770/5MGN	43	CD37/2CL	74	CD7PBL	75	CDAR883MMGN	44	CDLN770/3PLYE	50
AR770/5WE	43	CD37CL	74	CD7PCL	75	CDAR883MWE	44	CDLN770/3WEWE	47
AR770/6MGN	43	CD37QC	74	CD7PGY	75	CDCB108	77	CDLN777AWEWE	48
AR770/6WE	43	CD380	34	CD7PWE	75	CDCB116	77	CDLN777BLBL	48
B		CD390	34	CD84WE	35	CDCB120	77	CDLN777BLGL	48
BH1MS	105	CD400TMWE	47	CD90/15WE	74	CDCB132	77	CDLN777PLAS	51
BH1WE	105	CD401	73	CD90WE	74	CDCM777WE	65	CDLN777PLAU	51
BH2DWE	105	CD402	73	CD9WE	74	CDCM787WE	65	CDLN777PLKH	51
BH2NDMS	105	CD404	72	CDA770/1CXWE	64	CDCM910/1HWE	65	CDLN777PLMS	51

Cat. Nos	Page No	Cat. Nos	Page No	Cat. Nos	Page No	Cat. Nos	Page No	Cat. Nos	Page No
CDLN777PLOL	51	CDXL787PLSS	60	D		D359WE	35	DLI12501	16
CDLN777PLPI	51	CDXL787PLWE	60	D1001/1	35	D35P6	73	DLI12502	16
CDLN777PLSB	51	CDXL787WEWE	59	D1002/1	75	D360WE	34	DLI150TRIWE	15
CDLN777PLYE	51	CDXL787XWEWE	59	D102WE	94	D420/11	62	DLI7001	15
CDLN777WEMS	48	CDXLA770/1WEWE	58	D104PA6	81	D420/14	62	DLI70014P	15
CDLN777WEWE	48	CDXLA770/2WEWE	58	D104PACC	81	D420/15	62	DLI7002	15
CDLN777XBLBL	48	CDXLA770/3WEWE	58	D104PAUSBWE	81	D420/16	62	DLI70024P	15
CDLN777XBLGL	48	CDXLP777ESWEWE	59	D104PAWE	81	D420/19	62	DLI7003	15
CDLN777XPLAS	52	CDXLV777BLBL	60	D104WE	81	D420/1WE	62	DLI70034P	15
CDLN777XPLAU	52	CDXLV777PLMS	60	D105/1	81	D420/2WE	62	DLI7003BL	15
CDLN777XPLKH	52	CDXLV777PLWE	60	D105/12TRPA	81	D4USB	93	DLI7004	15
CDLN777XPLMS	52	CDXLV777WEWE	59	D105/12TRPPCC	81	D5101	88	DLI70044P	15
CDLN777XPLOL	52	CDXLV777XPLMS	60	D105/4TR	81	D5MBL	61	DLI7004BL	15
CDLN777XPLPI	52	CDXLV777XWEWE	59	D105/4TRPA	81	D5MWE	61	DLI7005	16
CDLN777XPLSB	52	CDXLV787BLBL	59	D105/5TRPA	81	D641/B	99	DLI70054P	16
CDLN777XPLYE	52	CDXLV787PLMS	60	D105/5TRPACC	81	D641/BFL	99	DLI70058P	16
CDLN777XWEMS	48	CDXLV787PLWE	60	D105CR100DS	89	D641/BLR	99	DLI7006	16
CDLN777XWEWE	48	CDXLV787WEWE	59	D105CR20XDS	89	D641/BLRCC	99	DLI70064P	16
CDLN787BLBL	48	CDXLW770V1WE	58	D105CR25HDS	89	D641/BPCC	99	DLI70068P	16
CDLN787WEWE	48	CF12H4WE	106	D105MS4WE	81	D641/BPWE	99	DLI7007	16
CDLNA770/1WEWE	47	CF12HBS	106	D105MS6RJWE	81	D641/PI	99	DLI70074P	16
CDLNA770/2WEWE	47	CF12HWE	160	D105MS6WE	81	D641/PIFL	99	DLI7008	16
CDV777WE	64	CF12J304	106	D105PA6	81	D641/PILR	99	DLI70084P	16
CDV787WE	64	CF12J316L	106	D105PA6CC	81	D642/01	99	DLI9001	15
CDXL1036WE	58	CF12J4WE	106	D105PA8	81	D642/012R	99	DLI90014P	15
CDXL300FWE	58	CF12JBS	106	D105PA8CC	81	D642/05	99	DLI9002	15
CDXL770/0WE	58	CF12JWE	106	D105PAUSBWE	81	D642/L1	99	DLI90024P	16
CDXL770/1BLBL	58	CF13HAW	106	D105PBOSS5	82	D642/L2	99	DLI9003	16
CDXL770/1CXWE	59	CF14H304	106	D105PBOSS5ELPA8	82	D642ELIOTWE	99	DLI90034P	16
CDXL770/1FOXWEW	59	CF14H4WE	106	D105PBOSSPA4	82	D642ELIOTBL	99	DLI9003BL	16
CDXL770/1PLMS	60	CF14HBS	106	D105PBOSSPA6	82	D642ELIOTKIT	99	DLI9004	16
CDXL770/1PLPB	60	CF14HWE	106	D105POD4	82	D770CXFP	62	DLI90044P	16
CDXL770/1PLSS	60	CF14J304	106	D105POD6	82	D770CXP	62	DLI9004BL	16
CDXL770/1PLWE	60	CF14J316L	106	D105SSPA4	82	D770CXPSE	62	DLI9005	16
CDXL770/1RJ2WEW	59	CF14J4WE	106	D105SSPA6	82	D809/1	93	DLI90054P	16
CDXL770/1WEWE	58	CF14JBS	106	D105TVAV4BL	81	D809/1DP	93	DLI90058P	16
CDXL770/2BLBL	58	CF14JWE	106	D105TVAV6BL	81	D809/1TWIN	93	DLI9006	16
CDXL770/2PLMS	60	CF9HBS	106	D105TVAV8BL	81	D809/1TWINDP	93	DLI90064P	16
CDXL770/2PLPB	60	CF9HWE	109	D1209/2.5	62	D809/1VP2DP	93	DLI90068P	16
CDXL770/2PLSS	60	CF9JBS	109	D121	94	D810/2	93	DLI9007	16
CDXL770/2PLWE	60	CF9JWE	109	D1210/2	62	D810/2DP	93	DLI90074P	16
CDXL770/2WEWE	58	CFBL12316L	107	D1211	62	D810SLIM	93	DLI9008	16
CDXL770/3BLBL	58	CFBL12BS	107	D1214/1	62	D810SLIMDP	93	DLI90084P	16
CDXL770/3FLHWE	58	CFBL12WE	107	D121A	94	D810SLIMTP	93	DLI903KTILTWE	15
CDXL770/3PLMS	60	CFBL14316L	107	D121E	94	D810SLIMTPDP	93	DLI904KTILTWE	15
CDXL770/3PLWE	60	CFBL14BS	107	D121UK	94	D817/2	94	DLI90TRIWE	15
CDXL770/3WEWE	58	CFBL14WE	107	D122	94	D817/2DP	94	DLS9001	17
CDXL770/4FLHHWE	58	CFBL9BS	107	D1233TC	93	D817SLIM	94	DLS9002	17
CDXL770/4WEWE	58	CFBL9WE	107	D1234HTC	93	D817SLIMDP	94	DLS9003	17
CDXL770/5WEWE	58	CFCLBS	107	D1235TC	93	D817SLIMTP	94	DLS9004	77
CDXL7774WEWE	59	CFCLWE	107	D1235WTC	93	D817SLIMTPDP	94	DMCB10	77
CDXL777BLBL	59	CFDR1500HWE	107	D123ATC	93	D818	93	DMCB16	77
CDXL777EL30	59	CFDR1500JWE	107	D123CTC31	93	D818DP	93	DMCB20	77
CDXL777PLMS	60	CFDR750HBS	107	D2/2WE	94	D818ODDP	93	DMCB32	77
CDXL777PLPB	60	CFDR750HWE	107	D2LWE	94	D819/2	93	DMCB6	77
CDXL777PLSS	60	CFDR750JBS	107	D2PA	94	D819/2DP	93	DMCBBASE	77
CDXL777PLWE	60	CFDR750JWE	107	D2PAB	94	D9500WE	35	DQ001	72
CDXL777WEWE	59	CF0LBS	107	D2USB	94	DCS1	61	DQ002	72
CDXL777XPLMS	60	CFOLLEDBS	107	D2USB121	93	DF20	34	DQ003	72
CDXL777XPLWE	60	CFOLLEDEWE	107	D2USBAC	93	DF40	34	DQ004	72
CDXL777XWEWE	59	CFOLWE	107	D2WE	94	DGLHS1	39	DQ005	72
CDXL787BLMS	60	CFREMOTEH	107	D303F	35	DGLS150	39	DQ006	72
CDXL787PLMS	60	CFREMOTEJ	107	D332WE	35	DGLWLED	39	DQ007	72
CDXL787PLPB	60	CL3B	72			DLI110TRIWE	15	DQ008	72
		CL4B	72						

Cat. Nos	Page No	Cat. Nos	Page No	Cat. Nos	Page No	Cat. Nos	Page No	Cat. Nos	Page No
DQ009	72	EV770/1RJ6GR	55	EVBTKGR	56	GL35WPLSS	38	LEP150WE	17
DQ010	72	EV770/1RJ6WE	55	EVBTKWE	56	GLLED003	38	LFL0110WBL	20
DQ011	72	EV770/1WE	53	EVBU777WE	54	GLLED004	38	LFL0110WBL	20
DQ105	72	EV770/2GMGR	53	EVHDMIUSBGR	56	GLLED005	38	LFL0120WBL	20
DQ107	72	EV770/2GMWE	53	EVHDMIUSBWE	56	GLLED006	38	LFL0120WBL	20
DQ108	72	EV770/2G0GR	56	EVM3FCWE	57	GLLED007	37	LFL0130WBL	20
DQ109	72	EV770/2G0WE	56	EVM400A2GR	57	GLLED008	37	LFL0130WBL	20
DQ110	72	EV770/2GR	53	EVM400A2WE	57	GLLED009	38	LFL0140WBL	20
DQ111	72	EV770/2RJ5EGR	55	EVM400A3GR	57	GLLEDPLBL	38	LFL0213WBL	20
DQ201	72	EV770/2RJ5EWE	55	EVM400A3WE	57	GLLEDPLSS	38	LFL0409WBL	20
DQU30	72	EV770/2RJ6GR	55	EVM770GR	57	GLLEDSSLBL	38	LFL0415WBL	20
DSLBAT4	39	EV770/2RJ6WE	55	EVM770IMGR	57	GLLEDSSLSS	38	LFL0510BL	20
DWS170	66	EV770/2WE	53	EVM770IMWE	57	H		LFL0520BL	20
DWS40	66	EV770/3FLHWE	53	EVM770LEDGR	57	HL100R80ES	33	LFL0530BL	20
DWS44	66	EV770/3GMGR	53	EVM770LEDWE	57	L		LFL0540BL	20
DWS44/777WE	66	EV770/3GMWE	53	EVM770TWE	57	L275HLES	105	LFS0110WBL	20
DWS53F/1WE	66	EV770/3G0GR	56	EVM770WE	57	L375HLES	105	LFS0130WBL	20
DWS53F/2WE	66	EV770/3G0WE	56	EVM883GR	57	LA60013KBC	24	LFS013KBL	20
E		EV770/3GR	53	EVM883WE	57	LA60013KES	24	LFS0214WBL	20
EF100/150TD	104	EV770/3WE	53	EVMFANKNOBGR	57	LA60014KBC	24	LFS0316WBL	20
EF100RDWE	103	EV770/40DPGR	53	EVMFANKNOBWE	57	LA60014KES	24	LFS0520BL	20
EF100SQSWE	103	EV770/40DPWE	53	EVMFFOXGR	57	LA6001BUGBC	24	LFS0530BL	20
EF100SQWE	103	EV770/4FLHHWE	53	EVMFFOXWE	57	LA6001BUGES	24	LG45013KBC	25
EF150RDWE	103	EV770/4GMGR	53	EVMPSGR	57	LA6001FILBC	24	LG45013KES	25
EF150SQSWE	103	EV770/4GMWE	53	EVMPSWE	57	LA6001FILES	24	LG45013KSBC	25
EF150SQWE	103	EV770/4G0GR	53	EVMUSB2ACGR	57	LA60023KBC	24	LG45013KSES	25
EF200RDMS	103	EV770/4G0WE	53	EVMUSB2ACWE	57	LA60023KBCD	24	LGU10013K	24
EF200RDWE	103	EV770/4GR	53	EVMUSB2PSAGR	57	LA60023KES	24	LGU10014K	24
EF200SQWE	103	EV770/4WE	53	EVMUSB2PSAWE	57	LA60023KESD	24	LLF014K1200	19
EF250RDMS	103	EV770/5GMGR	53	EVNLIGHTWE	56	LA60024KBC	24	LLF024K1200	19
EF250RDWE	103	EV770/5GMWE	53	EVPLBL	57	LA60024KES	24	LLF024K600	19
EF250SQWE	103	EV770/5G0GR	53	EVPLBU	56	LBD0112PS	19	LMR16703KWE	17
EFD01RDMS	103	EV770/5G0WE	53	EVPLCH	57	LBL014KBL	19	LMR16704KWE	17
EFD01RDWE	103	EV770/5GR	53	EVPLCO	56	LBL014KWE	19	LMR16903KWE	17
EFD01SQWE	103	EV770/5WE	53	EVPLDG	56	LBL024KBL	19	LMR16904KWE	17
EFGR200RDWE	103	EV770/6GMGR	53	EVPLGR	56	LBL024KWE	19	LMT0115W	34
EFGR250RDWE	103	EV770/6GMWE	53	EVPLKH	56	LBL034KBL	19	LN770/0PLAS	49
EFIL100SQWE	103	EV770/6G0GR	56	EVPLLG	56	LBL034KWE	19	LN770/0PLAU	49
EFIL150SQWE	103	EV770/6G0WE	56	EVPLMS	57	LBL044KBL	19	LN770/0PLBL	49
EFS150SQSWE	103	EV770/6GR	53	EVPLMT	57	LBL04EL4KBL	19	LN770/0PLCR	49
EFS150SQWE	103	EV770/6WE	53	EVPLPG	57	LCA013KSES	24	LN770/0PLDG	49
EV250LGR	54	EV777GMGR	53	EVPLPI	57	LCA01FILSES	24	LN770/0PLGL	49
EV250LWE	54	EV777GMWE	53	EVPLRD	57	LCA023KSES	24	LN770/0PLKH	49
EV250TGR	54	EV777GR	54	EVPLWE	57	LDK013K316	19	LN770/0PLLG	49
EV250TWE	54	EV777USB2ACGR	55	EVSENSORLIGHTGR	56	LDL013KPS	17	LN770/0PLMI	49
EV400PB2GR	54	EV777USB2ACWE	55	EVSENSORLIGHTWE	56	LDL013KWE	17	LN770/0PLMS	49
EV400PB2WE	54	EV777USB2IGR	55	EVSHUTTERWE	56	LDL014KPS	17	LN770/0PLOG	49
EV400PB3GR	54	EV777USB2IWE	55	EVSLIGHTWE	56	LDL014KWE	17	LN770/0PLOL	49
EV400PB3WE	54	EV777USB2PSAGR	55	EVTDWE	56	LDL023KPS	17	LN770/0PLPI	49
EV770/0GR	54	EV777USB2PSAWE	55	EW777GR	56	LDL023KWE	17	LN770/0PLRE	49
EV770/0WE	54	EV777WE	54	EW777WE	56	LDL024KPS	17	LN770/0PLSB	49
EV770/1CXGR	55	EV777XGMGR	55	EW777XGR	56	LDL024KWE	17	LN770/0PLVA	49
EV770/1CXWE	55	EV777XGMWE	54	EW777XWE	56	LDL033KPS	17	LN770/0PLWE	49
EV770/1FCGR	54	EV777XGR	55	EW787GR	56	LDL033KWE	17	LN770/0PLYE	49
EV770/1FCWE	54	EV777XWE	55	EW787WE	56	LDL034KPS	17	LN770/1PLCR	49
EV770/1FOXGR	55	EV787GMGR	54	EWWPADMS	56	LDL034KWE	17	LN770/1PLDG	49
EV770/1FOXWE	55	EV787GMWE	54	G		LDL043KPS	16	LN770/1PLLG	49
EV770/1GMGR	53	EV787GR	54	GL20WMPBLBL	38	LDL043KWE	16	LN770/1PLMI	49
EV770/1GMWE	53	EV787WE	54	GL20WMPBLBL4P	38	LDL044KPS	16	LN770/1PLOG	50
EV770/1G0GR	56	EV803PIRGR	56	GL20WMPLGR	38	LDL044KWE	16	LN770/1PLRE	50
EV770/1G0WE	56	EV803PIRWE	56	GL20WMSLBL	38	LDR01DECK	19	LN770/1PLVA	49
EV770/1GR	53	EVA770/1WE	54	GL20WSLSS	38	LDR01N700/36	18	LN770/2PLCR	50
EV770/1RJ5EGR	55	EVA770/2WE	54	GL35WPLBL	38	LDR02D700/18	18	LN770/2PLDG	50
EV770/1RJ5EWE	55	EVA770/3WE	54	GL35WPLBLH	38	LEP120WE	17	LN770/2PLLG	50

Cat. Nos	Page No	Cat. Nos	Page No	Cat. Nos	Page No	Cat. Nos	Page No	Cat. Nos	Page No
LN770/2PLMI	50	LPD033KPS	18	MAFTDBPB	32	MELST211ESN	27	MNGLS42ESF	31
LN770/2PLOG	50	LR63013KES	24	MAFTDCPB	32	MELST215BC	27	MNGLS52BCC	31
LN770/2PLRE	50	LR80023K	24	MAFTDGPB	32	MELST215ES	27	MNGLS52BCF	31
LN770/2PLVA	50	LR80024K	24	MAFTDRPB	32	MELST215ESN	27	MNGLS52ESC	31
LN770/3PLBL	50	LR80024KD	24	MAFTE	32	MELT28ESNS	25	MNGLS52ESF	31
LN770/3PLCR	50	LSL013K	18	MAFTECPB	32	MELTG11BC	25	MNGLS70BCC	31
LN770/3PLDG	51	LSP0112WBL	20	MAFXNBPB	32	MELTG11BCN	25	MNGLS70BCF	31
LN770/3PLLG	50	LSP0113KPS	18	MAFXNCPB	32	MELTG11ES	25	MNGLS70ESC	31
LN770/3PLMI	51	LSP0123KPS	18	MAFXTRBG	32	MELTG11ESN	25	MNGLS70ESF	31
LN770/3PLOG	51	LSP0125WBL	20	MAG9100C	31	MELTG15BC	25	MNGU1040	30
LN770/3PLRE	51	LSP0133KPS	18	MAG9100F	31	MELTG15BCN	25	MNR6342	31
LN770/3PLVA	51	LSS0112WBL	20	MAG940C	31	MELTG15ES	25	MP2050	33
LN770/3PLWE	51	LSS0125WBL	20	MAG940F	31	MELTG15ESN	25	MP38	33
LN777APLAS	52	LSS0209WBL	20	MAG940FX	31	MELTG9BC	25	MP38120	33
LN777APLAU	52	LST013KPS	18	MAG950C	31	MELTG9BCN	25	MP3880	33
LN777APLBL	52	LST013KWE	18	MAG975C	31	MELTG9ES	25	MP38CL	21
LN777APLCR	52	LST023KPS	18	MAG975F	31	MELTG9ESN	25	MP38CLED	20
LN777APLDG	52	LST023KWE	18	MAGX5P5P	34	MELTG9SES	25	MP38DB	33
LN777APLGL	52	LT150013KBC	25	MAGX5R5P	34	MELTS20BCS	26	MP38PERMF	21
LN777APLKH	52	LT200013KBC	25	MAGXHT5P	34	MELTS20ESS	26	MP38PERMFLED	20
LN777APLLG	52	LWK0220WBL	21	MALC113	21	MG30HG	28	MP38PF	21
LN777APLMI	52	LWK0240WBL	21	MALC113G9	22	MG40HG	28	MP38PFLED	20
LN777APLMS	52	LWL013KPS	19	MALC113G9SI	22	MG58HG	28	MPES181BP	21
LN777APLOG	52	LWL023KPS	19	MALC113G9W	22	MGLSSBOL01	38	MPES34	36
LN777APLOL	52	LWL023KWE	19	MALC113VP	22	MGU1040	32	MPES34B	36
LN777APLPI	52	LWL033KWE	19	MALC113VPLED	20	MGU1040E	32	MPES39B	22
LN777APLRE	52	LWL043KPS	19	MALC115	22	MGU1040G	32	MPES39BWP	22
LN777APLSB	52	LWL053KWE	19	MALC317	21	MGU1040R	32	MPES39G9	22
LN777APLVA	52	LWL063KBL	19	MALC317BC	21	MGU1515BCMCK	21	MPES40BL	
LN777APLWE	52	LWL063KPS	19	MALC515	21	MGU1515BCMCKT	21	MPES40GR	23
LN777APLYE	52	LWL073KPS	19	MALC515BC	21	MI15	28	MPES40WH	
LN777PLBL	51	LWL083KPS	19	MALC7WH	21	MI20	28	MPES66-3W	36
LN777PLCR	51	LWL093KBL	19	MAMR820CPB	32	MI40	28	MPES69	21
LN777PLDG	51	M		MAMR8CPB	32	MJ40	28	MPES69BVP	21
LN777PLGL	51	M5F114	23	MATEN38CPB	32	MJC1035	31	MPES69BWP	22
LN777PLLG	51	M5F128	23	MAWFLC4P	32	MJC2035	31	MPES69DIY	22
LN777PLMI	51	M5F214	23	MC08	29	MJC20CDP	31	MPES69G9	22
LN777PLOG	51	M5F228	23	MC10	29	MJC35CDP	31	MPES69G9SI	22
LN777PLRE	51	M5FD128	23	MC13	29	MK317WH35	21	MPES69G9W	22
LN777PLVA	15	M5FD214	23	MC15	29	MNCAN28BCF	30	MPES69WWP	22
LN777PLWE	51	M5FD228	23	MC37SDM	29	MNCAN28ESC	30	MPES700K35	21
LN777XPLBL	51	M5FD228LED	19	MCC18Y	27	MNCAN28ESF	30	MPES701	21
LN777XPLCR	51	M5R22CC	27	MCC36Y	27	MNCAN28SBCC	30	MPES760	23
LN777XPLDG	52	M5R22LC	27	MELMR11ESNS	27	MNCAN28SBCF	30	MPES761	22
LN777XPLGL	52	M5R22NC	27	MELQ48BCNS	26	MNCAN28SESC	30	MQ01SDP	33
LN777XPLLG	52	M5R32CC	27	MELQ48ESNS	26	MNCAN28SESF	30	MQ05C	33
LN777XPLMI	52	M5R32NC	27	MELQ48ESS	26	MNFRD28BCC	30	MQ05C6P	33
LN777XPLOG	52	M5R40CC	27	MELQAL11BC	26	MNFRD28BCF	30	MQ05DP	33
LN777XPPLRE	52	M5R40NC	27	MELQAL11BCN	26	MNFRD28ESC	30	MQ1LC	33
LN777XPLVA	52	M5T14CC	27	MELQAL11ESN	26	MNFRD28ESF	30	MQ275	105
LN777XPLWE	51	M5T14LC	27	MELQAL15BC	26	MNFRD28SBCC	30	MQ275DP	105
LOL004KWE	18	M5T14NC	27	MELQAL15BCN	26	MNFRD28SBCF	30	MR20CX	28
LOL013KWE	18	M5T21CC	27	MELQAL15ESN	26	MNFRD28SESC	30	MR20X	28
LOL014KWE	18	M5T28CC	27	MELQAL20BC	26	MNFRD28SESF	30	MR32CSG	28
LOL023KPS	18	M5T28D	27	MELQAL20BCN	26	MNG933	30	MR32CX	28
LOL024KPS	18	M5T28NC	27	MELQAL20ES	26	MNG942	30	MR32LX	28
LPA013KWE	17	M5T35NC	27	MELQAL20ESN	26	MNGLS28BCC	31	MR32SG	28
LPA014KWE	17	MABABBPB	32	MELS20BLKBC	26	MNGLS28BCF	31	MR32X	28
LPAR38013K	25	MABABCPB	32	MELS20BLKES	26	MNGLS28ESC	30	MR40CX	28
LPAR38024KES	25	MABABGPB	32	MELSBUG20BC	26	MNGLS28ESF	30	MR40X	29
LPD013KBL	18	MABABRPB	32	MELSBUG20ES	26	MNGLS42BCC	31	MRN22	28
LPD013KPS	18	MABABYPB	32	MELSD15ES	26	MNGLS42BCC2P	31	MRN22CX	28
LPD013KWE	18	MAFTD	32	MELSD20ES	26	MNGLS42BCF	31	MRN32	28
LPD023KWE	18	MAFTD2P	32	MELSD20ESN	26	MNGLS42ESC	30	MRN32CX	28

Cat. Nos	Page No	Cat. Nos	Page No	Cat. Nos	Page No	Cat. Nos	Page No
MRN32LX	28	R2705EB	87	RGLCL33/30	38	X	
MRN32NX	28	R2707	87	RGLHSC15	38	XL250LWE	58
MRN40	29	R2710	87	RGLKMVBL4	38	XL250TWE	58
MRN40CX	29	R2715	87	RGLKRSLD24	38	XL400TWE	58
MRT5YA22	23	R2720	87	RGLKRSLD4	38	XL770/1GPLWE	61
MRT5YA32	23	R2805	87	RGLKRSLDBL4	38	XL770/2GPLWE	61
MRT5YA40	23	R2810	87	RGLKSSM4	38	XL777XPLPB	60
MT08HG	29	R2810CLRCD	88	RGLKVSPBL4	38	XL777XPLSS	60
MT10HGX	29	R2810L	87	RGLLED001	39	Y	
MT13HG	29	R2810PBL	88	RGLLED002	39	YF4	71
MT15HGX	29	R2815	87	RGLLSP1M2	38	YR1	74
MT18CHGX	29	R2815GL	88	RGLPCTAW20	39	YR2	74
MT18CX	29	R2815L	87	RGLSPS1	38		
MT18D	28	R2820	88	RGLSSP2	38		
MT18HG	29	R2820L	87	RGLSSW1	39		
MT18HGX	29	R2820PBL	88	RGLSUP38	38		
MT18LX	29	R2825	89	RGLTR105	39		
MT18NX	28	R2825GL	88	RGLTR220	39		
MT36C	29	R2825L	87	RGLTR400	39		
MT36CX	29	R2908/15	88	RGLTR60	39		
MT36D	29	R2910/15CL	88	RGLVPLB	38		
MT36N	29	R2910/15CV	88	RGLVSBL	38		
MT36NX	29	R2910TL	88	RGLVSPBL	38		
MT37CHGX	29	R2915/15CV	88	RHH01	89		
MT37DHG	29	R2920	88	RQ16	73		
MT37DHGSP	29	R2920/15	88	RQ16WE	73		
MT37HG	29	R2920/15CL	88	RQ17	73		
MT37HGSP	29	R2920/15CV	88	RQ17BL	73		
MT37HGX	29	R2920TL	88	RQ17WE	73		
MTECOUG60T	34	R2925/15CV	88	RQ18	73		
MTECOUGAR60	34	R2930	88	RQ18BL	73		
MTECOUGAR60P	35	R2930TL	88	RQ710B	72		
MTETRADE65	35	R2935	88	RWL770/1MG	67		
MU22	28	R401B	73	RWL770/2MG	67		
MXMUSHR60F	33	R402B	73	RWL777MG	67		
MXR6340ES	33	R615	105	RWL787/15MG	67		
MXR6360ES	33	R620	103	RWL787MG	67		
MXR80100ES	33	R620LED	103	RWL787USBMG	67		
MXUP25BCC	33	R621D1	103	RWLC787MG	67		
MXUP25ESC	33	R621D2DA	104	RWLF770/1MG	67		
MXUP25SESC	33	R622D1	105	RWLF770/2MG	67		
N		R622D2	105	RWLF777MG	67		
NWP4228	23	R770USB2PSMBL	62	RWLF787MG	67		
P		R770USB2PSMWE	62	RXL777USB2PSWE	59		
PS2USB	93	RAR770USB2PSMMG	45	T			
PS2USBAC	93	RAR770USB2PSMWE	45	TV7IN1	35		
PS5USB	93	RCR2	89	TVPROX240	35		
R		REPC11015	82	W			
R102WE	94	REPC410	82	WMALCIT	34		
R105	81	REPC410USB	82	WS171/1	66		
R105/6	81	REPC410USBAC	82	WS171/2	66		
R105/6TWIN	81	REPC415	82	WS303/1F	66		
R1202	94	RGL1	38	WS40/15	66		
R143	71	RGL10	38	WS53/1MG	66		
R2601	87	RGL11	38	WS53/2MG	66		
R2602	87	RGL1215	38	WS54/1MG	66		
R2604	87	RGL21	38				
R2606	87	RGL22	38				
R2610	87	RGL3BL2P	38				
R2702	87	RGL8	38				
R2702EB	87	RGL9	38				
R2703	87	RGLAPSP2	38				
R2703EB	87	RGLBW2	38				
R2705	87	RGLCL21/30	38				



LIGHTING & SENSORS



P. 15
LED downlights

Fixtures



P. 20
LED floodlights



P. 24
LED globes
A60, R80,
GU10, and G45

Globes



P. 29
Fluorescent
T8 lam

Lighting accessories



P. 34
Battenholders

Sensors



P. 36
360°
Recessed
sensor

Garden lighting



P. 38
D.I.Y Halogen
garden lighting

FEATURED PRODUCTS



Downlights
(p. 15)



Lucita spotlights
(p. 18)



Selenta bunker lights
(p. 19)



P. 18
LED
oysters



P. 18
LED
pendants



P. 19
LED
battens



P. 19
LED
wall lights



P. 19
LED
bunker lights



P. 21
LED
worklights



P. 22
Incandescent
and Halogen
floodlights



P. 23
Flourescent
battens



P. 25
LED
PAR38 globe



P. 25
LED LT globe



P. 26
CFL triple
and quad tube



P. 27
Flourescent
globes



P. 28
T8 lamps and
circular lamps



P. 30
Ehalogen
globes



P. 31
Ehalogen
and Halogen
lamps



P. 32
Halogen
lamps



P. 34
Magnetic
transformer



P. 35
Lampholders



P. 35
Testers



P. 36
IP44
weatherproof
Sensor



P. 36
IP66
weatherproof
sensor



P. 39
D.I.Y LED
garden lighting



P. 39
Garden lighting
12V d.c.
accessories



**Fina
Floodlights**
(p. 20)



**The Lilo
Garden lights**
(p. 38)

Lighting & sensors solutions



MR16 LED RETROFIT DOWNLIGHTS

Upgrade old halogen downlights easily with **HPM MR16 Retrofit LED downlights** and enjoy maximum brightness, a contemporary sleek design and up to **70% energy savings**.



"Do It Yourself" installation in 3 easy steps:

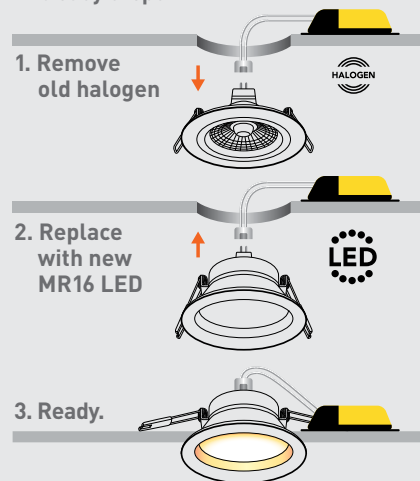

LED LIGHTING FIXTURES

Create ambience and make a space feel more beautiful with our task lighting superstars. Whether you're after ceiling lights, downlights or a decorative wall light, we've got you covered.



LED GLOBES

Replace your old globes with our long-lasting LED alternatives and start saving energy, pronto. Whether you need a PAR38 or an A60, we are expanding our range everyday to cover your needs.



FLOODLIGHTS

If you're lighting a suburban backyard, it's not usually the size of a football field, so you won't need the power and expense of a commercial floodlight. You need something that's fit for purpose. That's where we can help.



Lighting and sensors

LED Fixtures



DLI90TRIWE



DLI903KTILTWE



DLI7001



DLI7003BL



DLI9003



DLI9004BL

Cat.Nos	Indoor	Pack	Barcode	Single qty	Inner qty	Outer qty
Integrated driver LED dimmable downlights						
Selectable colour temperature Integrated driver LED dimmable downlights						
DLI90TRIWE	7W DLI 750-840-840 lm warm/cool/natural 3000-4000-5000K white 90mm cut-out dim		BX	9321001463733	1	- 24
DLI110TRIWE	7W DLI 750-840-840 lm warm/cool/natural 3000-4000-5000K white 100mm cut-out dim		BX	9321001463740	1	- 24
DLI150TRIWE	10W DLI 1000-1100-1000 lm warm/cool/natural 3000-4000-5000K white 150mm cut-out dim		BX	9321001463757	1	- 24
Tilt decorative - Integrated driver LED dimmable downlights						
DLI903KTILTWE	7W DLI 700 lm tilt decorative warm white 3000K chrome 90mm cut-out dim		BX	9321001469384	1	- 24
DLI904KTILTWE	7W DLI 820 lm tilt decorative cool white 4000K chrome 90mm cut-out dim		BX	9321001469391	1	- 24
70mm diameter cut-out						
DLI7001	5W DLI 505 lm warm white 3000K white 70mm cut-out dim		BX	9321001455134	1	- 48
DLI7002	5W DLI 515 lm cool white 4000K white 70mm cut-out dim		BX	9321001455141	1	- 48
DLI7003	5W DLI 505 lm warm white 3000K brushed chrome 70mm cut-out dim		BX	9321001455493	1	- 48
DLI7004	5W DLI 515 lm cool white 4000K brushed chrome 70mm cut-out dim		BX	9321001455509	1	- 48
DLI7003BL	5W DLI 505 lm warm white 3000K black 70mm cut-out dim		BX	9321001481270	1	- 48
DLI7004BL	5W DLI 515 lm cool white 4000K black 70mm cut-out dim		BX	9321001481294	1	- 48
DLI70014P	5W DLI 505 lm warm white 3000K white 70mm cut-out dim 4 pack		BX	9321001457008	4	- 36
DLI70024P	5W DLI 515 lm cool white 4000K white 70mm cut-out dim 4 pack		BX	9321001483564	4	- 36
DLI70034P	5W DLI 505 lm warm white 3000K brushed chrome 70mm cut-out dim 4 pack		BX	9321001487111	4	- 36
DLI70044P	5W DLI 515 lm cool white 4000K brushed chrome 70mm cut-out dim 4 pack		BX	9321001487135	4	- 36
90mm diameter cut-out						
DLI9001	7W DLI 700 lm warm white 3000K white 90mm cut-out dim		BX	9321001451655	1	- 24
DLI9002	7W DLI 820 lm cool white 4000K white 90mm cut-out dim		BX	9321001451662	1	- 24
DLI9003	7W DLI 700 lm warm white 3000K brushed chrome 90mm cut-out dim		BX	9321001455479	1	- 24
DLI9004	7W DLI 820 lm cool white 4000K brushed chrome 90mm cut-out dim		BX	9321001455486	1	- 24
DLI9003BL	7W DLI 700 lm warm white 3000K black 90mm cut-out dim		BX	9321001481317	1	- 24
DLI9004BL	7W DLI 820 lm cool white 4000K black 90mm cut-out dim		BX	9321001481331	1	- 24
DLI90014P	7W DLI 700 lm warm white 3000K white 90mm cut-out dim 4 pack		BX	9321001454427	4	- 24



Insulation Contact (IC) recessed luminaire - building insulation that can be continuously exposed to 90°C, can safely abut and cover the luminaire



Insulation Contact - Fire Resistant (IC-4) recessed luminaire - building insulation that can be continuously exposed to 90°C can safely abut and cover the luminaire. Additionally, IC-4 rated downlights have to pass a 1mm probe test i.e. a 1mm diameter probe cannot enter any part of the luminaire and in effect no insulation or any other material can enter the fitting.



New product



Energy Saving products



More info available. See technical pages



Coming soon



Product to be discontinued



Product only available in New Zealand

Lighting and sensors

LED Fixtures



LDL043KPS



DLI12502



DLI7005























































































DLI7008





DLI9006





DLI9008

Cat.Nos	Integrated driver LED dimmable downlights	Pack	Barcode	Single qty	Inner qty	Outer qty
DLI90024P	7W DLI 820 lm cool white 4000K white 90mm cut-out dim 4 pack   	BX	9321001483571	4	-	24
DLI90034P	7W DLI 700 lm warm white 3000K brushed chrome 90mm cut-out dim 4 pack   	BX	9321001487159	4	-	24
DLI90044P	7W DLI 820 lm cool white 4000K brushed chrome 90mm cut-out dim 4 pack   	BX	9321001487173	4	-	24
LDL043KWE	8W AZA+ 750 lm warm white 3000K white 90mm cut-out dim  	BX	9321001449249	1	-	20
LDL044KWE	8W AZA+ 820 lm cool white 4000K white 90mm cut-out dim   	BX	9321001449256	1	-	20
LDL043KPS	8W AZA+750 lm warm white 3000K polished silver 90mm cut-out dim   	BX	9321001463955	1	-	20
LDL044KPS	8W AZA+820 lm warm white 4000K polished silver 90mm cut-out dim   	BX	9321001463962	1	-	20
125mm diameter cut-out						
DLI12501	7W 750 lm warm white 3000K white 125mm cut-out dim  	BX	9321001451679	1	-	24
DLI12502	7W 880 lm cool white 4000K white 125mm cut-out dim  	BX	9321001451686	1	-	24
LED non dimmable downlights with integrated driver						
70mm diameter cut-out						
DLI7005	5W DLI 480 lm warm white 3000K white 70mm cut-out dim   	BX	9321001461258	1	-	48
DLI7006	5W DLI 505 lm cool white 4000K white 70mm cut-out dim   	BX	9321001461265	1	-	48
DLI7007	5W DLI 480 lm warm white 3000K brushed chrome 70mm cut-out dim   	BX	9321001461272	1	-	48
DLI7008	5W DLI 505 lm cool white 4000K brushed chrome 70mm cut-out dim   	BX	9321001461289	1	-	48
DLI70054P	5W DLI 480 lm warm white 3000K white 70mm cut-out dim 4 pack   	BX	9321001461333	4	-	48
DLI70064P	5W DLI 505 lm cool white 4000K white 70mm cut-out dim 4 pack   	BX	9321001483588	4	-	48
DLI70074P	5W DLI 480 lm warm white 3000K brushed chrome 70mm cut-out dim 4 pack   	BX	9321001487036	4	-	48
DLI70084P	5W DLI 505 lm cool white 4000K brushed chrome 70mm cut-out dim 4 pack   	BX	9321001487050	4	-	48
DLI70058P	5W DLI 480 lm warm white 3000K white 70mm cut-out dim 8 pack   	BX	9321001461340	8	-	64
DLI70068P	5W DLI 505 lm cool white 4000K white 70mm cut-out dim 8 pack   	BX	9321001483595	8	-	64
90mm diameter cut-out						
DLI9005	7W DLI 740 lm warm white 3000K white 90mm cut-out dim   	BX	9321001461296	1	-	24
DLI9006	7W DLI 815 lm cool white 4000K white 90mm cut-out dim   	BX	9321001461302	1	-	24
DLI9007	7W DLI 740 lm warm white 3000K brushed chrome 90mm cut-out dim   	BX	9321001461319	1	-	24
DLI9008	7W DLI 815 lm cool white 4000K brushed chrome 90mm cut-out dim   	BX	9321001461326	1	-	24
DLI90054P	7W DLI 740 lm warm white 3000K white 90mm cut-out dim 4 pack   	BX	9321001461357	4	-	48
DLI90064P	7W DLI 815 lm cool white 4000K white 90mm cut-out dim 4 pack   	BX	9321001483601	4	-	48
DLI90074P	7W DLI 740 lm warm white 3000K brushed chrome 90mm cut-out dim 4 pack   	BX	9321001487074	4	-	48
DLI90084P	7W DLI 815 lm cool white 4000K brushed chrome 90mm cut-out dim 4 pack   	BX	9321001487098	4	-	48
DLI90058P	7W DLI 740 lm warm white 3000K white 90mm cut-out dim 8 pack   	BX	9321001461364	8	-	64
DLI90068P	7W DLI 815 lm cool white 4000K white 90mm cut-out dim 8 pack   	BX	9321001483618	8	-	64

 New product

 Energy Saving products

 More info available. See technical pages

 Coming soon

 Product to be discontinued

 Product only available in New Zealand

CS = Clam Shell, BL = Blister pack, BX = Box, SL = Sleeve, HSL = Hang sell sleeve, HBG = Hang sell bag, HBX = Hang sell box, TG = Tag. For more details on packaging see page 4.

Lighting and sensors

LED Fixtures



LDL033KPS



DLS9001



LDL024KPS













































LEP120WE



LPA014KWE



LMR16703KWE

Cat.Nos	External driver LED dimmable downlights	Pack	Barcode	Single qty	Inner qty	Outer qty
70mm diameter cut-out						
LDL033KWE	9W FREESIA 500 lm warm white 3000K white 70mm cut-out dim  	BX	9321001434801	1	-	20
LDL034KWE	9W FREESIA 500 lm cool white 4000K white 70mm cut-out dim  	BX	9321001434825	1	-	20
LDL033KPS	9W FREESIA 500 lm warm white 3000K polished aluminium 70mm cut-out dim  	BX	9321001434818	1	-	20
LDL034KPS	9W FREESIA 500 lm cool white 4000K polished aluminium 70mm cut-out dim  	BX	9321001434832	1	-	20
90mm diameter cut-out						
DLS9001	10W DLS 830 lm warm white 3000K white 90mm cut-out dim  	BX	9321001431565	1	-	24
DLS9002	10W DLS 835 lm cool white 4000K white 90mm cut-out dim  	BX	9321001431572	1	-	24
DLS9003	10W DLS 830 lm warm white 3000K brushed chrome 90mm cut-out dim  	BX	9321001431589	1	-	24
DLS9004	10W DLS 835 lm cool white 4000K brushed chrome 90mm cut-out dim  	BX	9321001431596	1	-	24
LDL013KWE	11W AZALEA 800 lm warm white 3000K white 90mm cut-out dim  	BX	9321001432883	1	-	20
LDL014KWE	11W AZALEA 850 lm cool white 4000K white 90mm cut-out dim  	BX	9321001432890	1	-	20
LDL013KPS	11W AZALEA 800 lm warm white 3000K polished aluminium 90mm cut-out dim  	BX	9321001432906	1	-	20
LDL014KPS	11W AZALEA 850 lm cool white 4000K polished aluminium 90mm cut-out dim  	BX	9321001432913	1	-	20
LDL023KWE	15W DALIA 950 lm warm white 3000K white 90mm cut-out dim  	BX	9321001432920	1	-	20
LDL024KWE	15W DALIA 980 lm cool white 4000K white 90mm cut-out dim  	BX	9321001432937	1	-	20
LDL023KPS	15W DALIA 950 lm warm white 3000K anodised aluminium 90mm cut-out dim  	BX	9321001432944	1	-	20
LDL024KPS	15W DALIA 980 lm cool white 4000K anodised aluminium 90mm cut-out dim  	BX	9321001432951	1	-	20
Downlights extension plates						
LEP120WE	For holes up to Ø120mm for 90mm cut-out downlights	TG	9321001441601	1	-	96
LEP150WE	For holes up to Ø150mm for 90mm cut-out downlights	TG	9321001441618	1	-	96
LED panel lights						
LPA013KWE	18W LUNA 1440 lm warm white 3000K white finish 225mm cut-out dim  	BX	9321001432999	1	-	10
LPA014KWE	18W LUNA 1500 lm cool white 4000K white finish 225mm cut-out dim  	BX	9321001437499	1	-	10
LED MR16 retrofit downlights 12V - DIY						
LMR16703KWE	7W warm white 3000K 550 lm white 70mm cut-out 	BX	9321001449300	1	16	64
LMR16704KWE	7W cool white 4000K 590 lm white 70mm cut-out 	BX	9321001449317	1	16	64
LMR16903KWE	9W warm white 3000K 710 lm white 90mm cut-out  	BX	9321001449324	1	12	48
LMR16904KWE	9W cool white 4000K 770 lm white 90mm cut-out  	BX	9321001449331	1	12	48

Lighting and sensors

LED Fixtures



Cat.Nos	LED oysters lights		Pack	Barcode	Single qty	Inner qty	Outer qty
LOL013KWE	17W ATIS 1650 lm warm white 3000K white dimmable		BX	9321001455974	1	-	6
LOL014KWE	17W ATIS 1750 lm cool white 4000K white dimmable		BX	9321001455981	1	-	6
LOL023KPS	18W AURA 1520 lm warm white 3000K silver dimmable		BX	9321001449287	1	-	4
LOL024KPS	18W AURA 1550 lm cool white 4000K silver dimmable		BX	9321001449294	1	-	4
LED oysters lights non dimmable							
LOL004KWE	17W ATIS 1500 lm cool white 3000K white		BX	9321001469506	1	-	6
LED step and star lights							
LST013KWE	2.4W CALLA 24 lm warm white 3000K white 45mm cut-out		BX	9321001433002	1	-	100
LST013KPS	2.4W CALLA 24 lm warm white 3000K silver 45mm cut-out		BX	9321001433019	1	-	100
LST023KWE	2.4W ZINNIA 95 lm warm white 3000K white finish 32mm dimmable		BX	9321001433026	1	-	100
LST023KPS	2.4W ZINNIA 95 lm warm white 3000K polished aluminium 32mm dimmable		BX	9321001433033	1	-	100
LDR02D700/18	18W driver kit for ZINNIA/CALLA LED step lights & starlights (min load 5W)		BX	9321001433064	1	-	50
LED spotlight							
LSP0113KPS	7W LUCITA Dimmable LED adjustable spotlight silver		BX	9321001464990	1	-	30
LSP0123KPS	2 x 7W LUCITA Dimmable LED adjustable spotlight silver		BX	9321001465003	1	-	16
LSP0133KPS	3 x 7W LUCITA Dimmable LED adjustable spotlight silver		BX	9321001465010	1	-	10
LED pendants lights							
LPD013KWE	7W CYLLA pendant 560ml warm white 3000K die-cast aluminium white		BX	9321001449218	1	-	12
LPD013KPS	7W CYLLA pendant 560ml warm white 3000K die-cast aluminium silver		BX	9321001449195	1	-	12
LPD013KBL	7W CYLLA pendant 560ml warm white 3000K die-cast aluminium black		BX	9321001449201	1	-	12
LPD033KPS	8W PENDI pendant 320ml warm white 3000K die-cast aluminium silver		BX	9321001449232	1	-	6
LPD023KWE	8W CERSI pendant 570ml warm white 3000K die-cast aluminium white		BX	9321001449225	1	-	6
LED wall lights							
LWL053KWE	8.3W KORA up/downlight 335 lm warm white 3000K white indoor		BX	9321001447269	1	-	24
LED striplights							
LDR01N700/36	36W RIBBA driver and 1m strip 600 lm warm white 3000K up to 5m strip		BX	9321001433057	1	-	24
LSL013K	7W RIBBA 600 lm strip warm white 3000K 1m length		BX	9321001433040	1	-	24

Lighting and sensors

LED Fixtures



M5FD228LED



LBL014KBL



LWL093KBL



LWL073KPS



LBD0112PS



LBL044KBL

Cat.Nos	LED battens - HPM		Pack	Barcode	Single qty	Inner qty	Outer qty
LLF024K600	18W LED Blade 1700 lm cool white 4000K white 600mm		BX	9321001480822	1	-	10
LLF024K1200	36W LED Blade 3600 lm cool white 4000K white 1200mm		BX	9321001480778	1	-	10
M5FD228LED	40W LED Slimline 4400 lm cool white 4000K white 1200mm		BX	9321001481393	1	-	6
LLF014K1200	40W LED Linear 4000 lm white 4000K cool white 1200mm		BX	9321001470267	1	-	6
Outdoor							
LED deck lights							
LDK013K316	0.6W DECKIA 20 lm warm white 3000K silver 28mm cut-out dim		BX	9321001442059	1	-	50
LDR01DECK	DECKIA Deck driver Kit		BX	9321001442073	4	-	40
LED wall lights							
LWL013KPS	10W PINNA up/downlight 380 lm warm white 3000K anodised aluminium IP54		BX	9321001432968	1	-	24
LWL023KPS	7.5W KYRA up/downlight 430 lm warm white 3000K anodised aluminium IP54		BX	9321001432975	1	-	24
LWL023KWE	7.5W KYRA up/downlight 430 lm warm white 3000K anodised white IP54		BX	9321001464914	1	-	24
LWL063KPS	7W MIKA up/downlight 350 lm warm white 3000K anodised aluminium IP54		BX	9321001441588	1	-	12
LWL063KBL	7W MIKA up/downlight 350 lm warm white 3000K anodised black IP54		BX	9321001464938	1	-	12
LWL093KBL	13W SPARTIKA up/downlight 500 lm warm white 3000K anodised black IP54		BX	9321001465072	1	-	12
LWL043KPS	2x 2.2W TALANTA up/downlight 120 lm warm white 3000K anodised aluminium IP55		BX	9321001474746	1	-	12
LWL073KPS	10W KATYA Adjustable 720 lm warm white 3000K aluminium IP65		BX	9321001464976	1	-	12
LWL083KPS	9W ROTAYA Adjustable 600 lm warm white 3000K aluminium IP65		BX	9321001464952	1	-	12
LED bollard Light							
LBD0112PS	10W GLAMA 240V 600mm Aluminium LED Bollard		BX	9321001465096	1	-	6
LED bunker light							
LBL014KWE	12W OROYA 870 lm cool white 4000K white Ø270mm IP65		BX	9321001454885	1	-	6
LBL014KBL	12W OROYA 870 lm cool white 4000K black Ø270mm IP65		BX	9321001465058	1	-	6
LBL044KBL	7W OVALIA 485 lm cool white black IP65		BX	9321001469308	1	-	20
LBL04EL4KBL	6W OVALIA Eyelid 420 lm cool white black IP65		BX	9321001469315	1	-	20
LBL024KWE	12W SELENTA 870 lm cool white white IP65		BX	9321001469421	1	-	6
LBL024KBL	12W SELENTA 870 lm cool white black IP65		BX	9321001469438	1	-	6
LBL034KWE	17W ELLIPTICA 1700 lm cool white white IP65		BX	9321001469346	1	-	12
LBL034KBL	17W ELLIPTICA 1700 lm cool white black IP66		BX	9321001469353	1	-	12

New product

Energy Saving products

More info available. See technical pages

Coming soon

Product to be discontinued

Product only available in New Zealand

CS = Clam Shell, BL = Blister pack, BX = Box, SL = Sleeve, HSL = Hang sell sleeve, HBG = Hang sell bag, HBX = Hang sell box, TG = Tag. For more details on packaging see page 4.

Lighting and sensors

LED Fixtures



LFL0409WBL



LFL0520BL



MP38PFLED



LSS0209WBL



LFS0214WBL



LFL0120WBL

Cat.Nos	LED floodlights		Pack	Barcode	Single qty	Inner qty	Outer qty
LFL0409WBL	9W FINA 800lm Slime LED cool white 4000K IP65 black glass		CS	9321001463894	1	-	16
LFL0415WBL	15W FINA 1490lm Slime LED cool white 4000K IP65 black glass		CS	9321001463900	1	-	16
LFL0510BL	8W LEANA 650 lm Slimline LED cool white IP65 black		BX	9321001465119	1	-	36
LFL0520BL	15W LEANA 1200 lm Slimline LED cool white IP65 black		BX	9321001465126	1	-	36
LFL0530BL	20W LEANA 2000 lm Slimline LED cool white IP65 black		BX	9321001465133	1	-	20
LFL0540BL	30W LEANA 3000 lm Slimline LED cool white IP65 black		BX	9321001465140	1	-	16
LFS0520BL	15W LEANA 1200 lm Slimline LED with sensor cool white IP65 black		BX	9321001465157	1	-	36
LFS0530BL	20W LEANA 2000 lm Slimline LED with sensor cool white IP65 black		BX	9321001465164	1	-	20
MP38PERMFLED	8W 800 lm JENTA Single Perma Floodlight LED PAR38 IP44 black		BX	9321001483786	1	-	24
MP38PFLED	8W 800 lm JENTA Single Floodlight LED PAR38 IP44 black		BX	9321001483793	1	-	24
MP38CLLED	8W 800 lm JENTA Single Portable Floodlight LED PAR38 IP44 black		BX	9321001483809	1	-	24
MALC113VPLED	8W 800 lm JENTA Twin Floodlight LED 2x PAR38 IP44 black		BX	9321001483816	1	-	18
LFS013KBL	29W 2200 lm Twin PAR38 with PIR sensor warm white 3000K IP44 black		BX	9321001434788	1	-	10
LSS0209WBL	9W 990 lm MAXIS with PIR sensor cool white 4000K IP44 black		BX	9321001441311	1	-	8
LFL0213WBL	13W 1100 lm BAKRA cool white 4000K IP44 black		BX	9321001441175	1	-	10
LFS0214WBL	14W 1100 lm BAKRA with PIR sensor cool white 4000K IP44 black		BX	9321001441182	1	-	6
LFS0316WBL	16W 1700 lm TORAN with PIR sensor cool white 4000K IP44 black		BX	9321001441328	1	-	4
LFL0110WBL	10W 730 lm FORTA cool white 4000K IP44 black		BX	9321001441199	1	-	12
LFL0120WBL	20W 1615 lm FORTA cool white 4000K IP44 black		BX	9321001441205	1	-	6
LFL0130WBL	30W 2250 lm FORTA cool white 4000K IP44 black		BX	9321001441212	1	-	4
LFL0140WBL	40W 3000 lm FORTA cool white 4000K IP44 black		BX	9321001441229	1	-	4
LFS0110WBL	10W 730 lm FORTA with PIR sensor cool white 4000K IP44 black		BX	9321001441236	1	-	12
LFS0130WBL	30W 2250 lm FORTA with PIR sensor cool white 4000K IP44 black		BX	9321001441243	1	-	2
LSP0112WBL	11.5W 1070 lm SIKA cool white 4000K IP44 black		BX	9321001441274	1	-	6
LSP0125WBL	25W 2200 lm SIKA cool white 4000K IP44 black		BX	9321001441281	1	-	6
LSS0112WBL	11.5W 1070 lm SIKA with PIR sensor cool white 4000K IP44 black		BX	9321001441298	1	-	6
LSS0125WBL	25W 2200 lm SIKA with PIR sensor cool white 4000K IP44 black		BX	9321001441304	1	-	6

New product

Energy Saving products

More info available. See technical pages

Coming soon

Product to be discontinued

Product only available in New Zealand

CS = Clam Shell, BL = Blister pack, BX = Box, SL = Sleeve, HSL = Hang sell sleeve, HBG = Hang sell bag, HBX = Hang sell box, TG = Tag. For more details on packaging see page 4.

Lighting and sensors

Fixtures



LWK0110WBL



LWK0240WBL



MALC515



MP38PERMF



MP38PF



MPES181BP

Cat.Nos	LED worklights	Pack	Barcode	Single qty	Inner qty	Outer qty
Portable						
LWK0110WBL	10W 730 lm FORTA cool white 4000K IP44 black	BX	9321001450603	1	-	8
LWK0120WBL	20W 1615 lm FORTA cool white 4000K IP44 black	BX	9321001450610	1	-	8
LWK0130WBL	30W 2250 lm FORTA cool white 4000K IP44 black	BX	9321001450627	1	-	4
Tripod						
LWK0220WBL	2x10W 1460 lm FORTA cool white 4000K IP44 black	BX	9321001450634	1	-	2
LWK0240WBL	2x20W 3230 lm FORTA cool white 4000K IP44 black	BX	9321001450641	1	-	2
Halogen downlights - Nelson Indoor						
MR16 fixed						
MALC317	35W white 70mm cut-out no lamp	BX	9318416999315	1	-	60
MALC317BC	35W brushed chrome 70mm cut-out no lamp	BX	9318416018030	1	-	60
MK317WH35	35W white 70mm cut-out	BX	9318416074685	1	-	50
MR16 Gimble						
MALC515	35W white 90mm cut-out no lamp	BX	9318416999230	1	-	60
MALC515BC	35W brushed chrome 90mm cut-out no lamp	BX	9318416018023	1	-	60
GU10 Gimble						
MGU515BCMCKT	50W brushed chrome 90mm cut-out with mesh cover 10 pack	BX	9318416074548	10	-	4
Halogen downlights with movement sensor						
MPES700K35	35W MR16 white 100mm cut-out	BX	9318416074869	1	-	10
MPES701	50W GU10 white 100mm cut-out	BX	9318416068158	1	-	20
CFL downlights - Nelson						
MALC7WH	20W cool white 4000K white 130mm cut-out dimmable	BX	9318416067533	1	-	30
Outdoor floodlights - Nelson						
Incandescent floodlights						
MP38PERMF	150W single floodlight PAR38 IP44 black	BX	9318416061005	1	-	16
MP38CL	150W single portable floodlight PAR38 with clamp IP44 black	BX	9318416071011	1	-	20
MP38PF	150W single floodlight PAR38 with flex & plug IP44 black	BX	9318416059194	1	-	16
MALC113	Twin floodlight PAR38 IP44 black lamps not supplied	BX	9318416018016	1	-	20
MPES69	Twin floodlight PAR38 with PIR sensor manual override IP44 lamps not supplied black	BX	9318416013042	1	-	20
MPES181BP	300W twin floodlight PAR38 with PIR sensor IP44 black	BX	9321001410478	1	-	10
MPES69BVP	300W twin floodlight PAR38 with PIR sensor manual override IP44 black	BX	9318416057220	1	-	8

Lighting and sensors

Fixtures



R605/3



MPE539G9



RSSL603-2

Cat.Nos	Outdoor floodlights	Pack	Barcode	Single qty	Inner qty	Outer qty
Incandescent floodlights						
MALC113VP	300W twin floodlight PAR38 IP44 black	BX	9318416018016	1	-	10
MPES69DIY	DIY twin floodlight PAR38 with PIR sensor manual override IP44 lamps not supplied black	BX	9318416018009	1	-	20
MPES69BWP	Twin floodlight PAR38 with PIR sensor manual override IP65 lamps not supplied black	BX	9318416053352	1	-	20
MPES69WWP	Twin floodlight PAR38 with PIR sensor manual override IP65 lamps not supplied white	BX	9318416059378	1	-	20
Incandescent floodlights - Nelson						
MPES39B	150W PIR wall manual override 180° scan 12m range IP44 black	BX	9318416000912	1	-	20
MPES39BWP	150W PIR wall manual override 180° scan 12m range IP44 black	BX	9318416053369	1	-	20
Halogen floodlights						
R605/3	150W floodlight IP44 white	BX	9310539015491	1	-	20
Halogen floodlights - Nelson						
MPE539G9	100W motion sensor PIR black IP44 wall manual override 180° scan 12m range	BX	9318416065041	1	-	-
MALC113G9	200W Twin G9 floodlight IP44 black	BX	9318416065935	1	-	20
MALC113G9SI	200W Twin G9 floodlight IP44 silver	BX	9318416065959	1	-	20
MALC113G9W	200W Twin G9 floodlight IP44 white	BX	9318416065942	1	-	20
MPES69G9	200W Twin G9 floodlight with PIR sensor manual override IP44 black	BX	9318416065027	1	-	16
MPES69G9SI	200W Twin G9 floodlight with PIR sensor manual override IP44 silver	BX	9318416065287	1	-	16
MPES69G9W	200W Twin G9 floodlight with PIR sensor manual override IP44 white	BX	9318416065034	1	-	16
MALC115	1500W black IP55 heavy duty	BX	9318416060459	1	-	6
Solar security floodlights						
RSSL605/2	Silver aluminium solar security light 20,00hrs lifetime 130° sensor	BX	9321001393108	1	-	4

Lighting and sensors

Fluorescent battens



AJ236HT



NWP4228



MPES761

Cat.Nos	Fluorescent battens - Nelson	Pack	Barcode	Single qty	Inner qty	Outer qty
	T8					
AJ218HT	Battens T8 Jupitor 2x18W natural white 5000K white	BX	9325461000545	1	-	-
AJ236HT	Battens T8 Jupitor 2x36W natural white 5000K white	BX	9325461000576	1	-	-
	T5					
M5F114	Battens T5 slimline 14W cool white 4000K white	<input type="checkbox"/> BX	9318416064228	1	-	-
M5F228	Battens T5 slimline 2x28W cool white 4000K white	<input type="checkbox"/> BX	9318416060787	1	-	-
M5FD128	Battens T5 slimline 28W cool white 4000K white	<input type="checkbox"/> BX	9318416072827	1	-	-
M5FD214	Battens T5 slimline 2x14W cool white 4000K white	<input type="checkbox"/> BX	9318416065430	1	-	-
M5FD228	Battens T5 slimline 2x18W cool white 4000K white	BX	9318416059392	1	-	-
NWP4228	Battens T5 WP IP65 2x28W natural white 5000K grey	<input type="checkbox"/> BX	9318416059873	1	-	-
	Fluorescent oysters lights - Nelson					
MRT5YA22	22W T5 slimline cool white 4000K Ø295mm white	<input type="checkbox"/> BX	9318416059477	1	-	8
MRT5YA32	32W T5 slimline cool white 4000K Ø340mm white	BX	9318416060152	1	-	8
MRT5YA40	40W T5 slimline cool white 4000K Ø395mm white	<input type="checkbox"/> BX	9318416063191	1	-	6
MPES760	60W PIR ceiling manual override 100° scan 7m rg plastic white	BX	9318416057084	1	-	6
MPES761	60W PIR ceiling manual override 100° scan 7m rg plastic white	BX	9318416068172	1	-	4
	Coachlight - Nelson					
MPES40GR	75W PIR IP33 wall manual override 110° scan 12m range green	BX	9318416059309	1	-	6

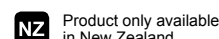
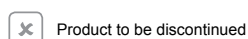
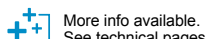
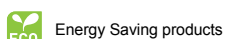
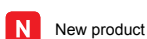

CS = Clam Shell, BL = Blister pack, BX = Box, SL = Sleeve, HSL = Hang sell sleeve, HBG = Hang sell bag, HBX = Hang sell box, TG = Tag. For more details on packaging see page 4.

Lighting and sensors

LED globes and anti-insect



LA60023KESD



LA60014KBC



LA6001FILES



LCA023KSES



LGU10013K

Cat.Nos	Globes		Pack	Barcode	Single qty	Inner qty	Outer qty
	LED A60 dimmable						
LA60023KESD	8W 875 lm warm white 3000K E27		BX	9321001461777	1	10	150
LA60023KBCD	8W 875 lm warm white 3000K B22		BX	9321001461784	1	10	150
	LED A60 non-dimmable						
	Edison E27						
LA60013KES	5W 490 lm warm white 3000K E27		BX	9321001449010	1	10	150
LA60014KES	5W 550 lm cool white 4000K E27		BX	9321001449027	1	10	150
LA60023KES	8W 945 lm warm white 3000K E27		BX	9321001449034	1	10	150
LA60024KES	8W 1035 lm cool white 4000K E27		BX	9321001449041	1	10	150
	Bayonet B22						
LA60013KBC	5W 490 lm warm white 3000K B22		BX	9321001449058	1	10	150
LA60014KBC	5W 550 lm cool white 4000K B22		BX	9321001449065	1	10	150
LA60023KBC	8W 945 lm warm white 3000K B22		BX	9321001449072	1	10	150
LA60024KBC	8W 1035 lm cool white 4000K B22		BX	9321001449089	1	10	150
	LED A60 filament						
LA6001FILES	3.7W 500 lm warm white 3000K E27		BX	9321001456018	1	10	50
LA6001FILBC	3.7W 500 lm warm white 3000K B22		BX	9321001456025	1	10	50
	LED A60 insect globes						
LA6001BUGES	5W 460 lm yellow E27		BX	9321001456711	1	10	150
LA6001BUGBC	5W 460 lm yellow B22		BX	9321001456728	1	10	150
	LED R63						
LR63013KES	5.7W 570 lm warm white 3000K E27		BX	9321001448891	1	12	96
	LED R80						
LR80023K	7W 580 lm warm white 3000K E27		BX	9321001447993	1	10	60
LR80024K	7W 700 lm cool white 4000K E27		BX	9321001448006	1	10	60
	LED candle						
LCA023KSES	5W 560 lm warm white 3000K E14		BX	93210014457374	1	24	192
	LED GU10						
LGU10013K	5W 460 lm warm white 3000K		BX	9321001448907	1	10	100
LGU10014K	5W 500 lm cool white 4000K		BX	9321001448914	1	10	100

New product

Energy Saving products

More info available. See technical pages

Coming soon

Product to be discontinued

Product only available in New Zealand

CS = Clam Shell, BL = Blister pack, BX = Box, SL = Sleeve, HSL = Hang sell sleeve, HBG = Hang sell bag, HBX = Hang sell box, TG = Tag. For more details on packaging see page 4.

Lighting and sensors

LED & CFL globes



LG45013KES



LG45013KSBC



LPAR38013K



LPAR38024KES



LT150013KBC

Cat.Nos	LED G45		Pack	Barcode	Single qty	Inner qty	Outer qty
LG45013KES	4W 420 lm warm white 3000K E27		BX	9321001463993	1	12	108
LG45013KSES	4W 420 lm warm white 3000K E14		BX	9321001464006	1	10	60
LG45013KBC	4W 420 lm warm white 3000K B22		BX	9321001464013	1	10	60
LG45013KSBC	4W 420 lm warm white 3000K B15		BX	9321001464020	1	10	60
LED PAR38							
LPAR38013K	14W 1100 lm warm white 3000K E27		BX	9321001441113	1	-	12
LPAR38024KES	8W 800 lm cool white 4000K E27 plastic black finish		BX	9321001469476	1	-	20
LED LT globe							
LT150013KBC	12W 1100 lm warm white T150 Globe		BX	9321001462507	1	-	32
LT200013KBC	19W 1700 lm warm white T200 Globe		BX	9321001462514	1	-	24
Electrozap insect killer - Nelson							
MBIK40	Insect killer Electrozap fluorescent 40W white		BX	9318416021863	1	-	-
CFL quad tube - Nelson							
Edison E14							
MELTG9SES	9W E14 warm white 3000K 6000h		BX	9318416068967	1	-	50
Edison E27							
MELTG9ES	9W E27 warm white 3000K 6000h		BX	9318416068929	1	-	50
MELTG9ESN	9W E27 natural white 5000K 6000h		BX	9318416068912	1	-	50
MELTG11ES	11W E27 warm white 3000K 6000h		BX	9318416069001	1	-	50
MELTG11ESN	11W E27 natural white 5000K 6000h		BX	9318416068998	1	-	50
MELTG15ES	15W E27 warm white 3000K 6000h		BX	9318416069087	1	-	50
MELTG15ESN	15W E27 natural white 5000K 6000h		BX	9318416069070	1	-	50
MELT28ESNS	28W E27 natural white 5000K 6000h		CS	9318416054267	1	10	100
Bayonet B22							
MELTG9BC	9W B22 warm white 3000K 6000h		BX	9318416068943	1	-	50
MELTG9BCN	9W B22 natural white 5000K 6000h		BX	9318416068936	1	-	50
MELTG11BC	11W B22 warm white 3000K 6000h		BX	9318416069025	1	-	50
MELTG11BCN	11W B22 natural white 5000K 6000h		BX	9318416069018	1	-	50
MELTG15BC	15W B22 warm white 3000K 6000h		BX	9318416069100	1	-	50
MELTG15BCN	15W B22 natural white 5000K 6000h		BX	9318416069094	1	-	50

New product

Energy Saving products

More info available. See technical pages

Coming soon

Product to be discontinued

Product only available in New Zealand

CS = Clam Shell, BL = Blister pack, BX = Box, SL = Sleeve, HSL = Hang sell sleeve, HBG = Hang sell bag, HBX = Hang sell box, TG = Tag. For more details on packaging see page 4.

Lighting and sensors

Circular lamps



MELQAL11BC



MELSD20ESN



MELSBUG20ES



MELS20BLKES

Cat.Nos		Pack	Barcode	Single qty	Inner qty	Outer qty
CFL quad tube - Nelson						
Edison E27						
MELQAL11ESN	11W E27 natural white 5000K 6000h	✕ BX	9318416058944	1	-	50
MELQAL15ESN	15W E27 natural white 5000K 6000h	✕ BX	9318416058982	1	10	50
MELQAL20ES	15W E27 warm white 3000K 6000h	✕ CS	9318416066031	1	5	20
MELQAL20ESN	20W E27 natural white 5000K 6000h	✕ CS	9318416066024	1	5	20
MELQ48ESS	48W E27 warm white 3000K 6000h	✕ BX	9318416054618	1	-	25
MELQ48ESNS	48W E27 natural white 5000K 6000h	✕ BX	9318416054625	1	20	100
CFL quad tube - Nelson						
Bayonet B22						
MELQAL11BC	11W B22 warm white 3000K 6000h	✕ BX	9318416058937	1	-	50
MELQAL11BCN	11W B22 natural white 5000K 6000h	✕ BX	9318416058920	1	-	50
MELQAL15BC	15W B22 warm white 3000K 6000h	✕ CS	9318416058975	1	-	50
MELQAL15BCN	15W B22 natural white 5000K 6000h	✕ BX	9318416058968	1	10	50
MELQAL20BC	20W B22 warm white 3000K 6000h	✕ CS	9318416066017	1	5	100
MELQAL20BCN	20W B22 natural white 5000K 6000h	✕ CS	9318416066000	1	20	100
MELQ48BCNS	48W B22 natural white 5000K 6000h	✕ BX	9318416054601	1	-	25
CFL spiral - Nelson						
Edison E27						
MELSD15ES	15W E27 warm white 3000K dimmable	✕ BX	9318416070526	1	20	100
MELSD20ES	20W E27 warm white 3000K 10000h dimmable	✕ BX	9318416070564	1	20	100
MELSD20ESN	20W E27 natural white 5000K 10000h dimmable	✕ BX	9318416070588	1	20	100
MELTS20ESS	20W E27 warm white 3000K 6000h spherical	✕ BX	9318416054410	1	-	20
MELS105GESCW	105W E27 cool white 4000K 6000h	✕ BX	9318416072858	1	-	10
Bayonet B22						
MELTS20BCS	20W B22 warm white 3000K 6000h	✕ BX	9318416054397	1	-	20
CFL anti insect - Nelson						
MELSBUG20ES	20W E27 yellow 5000K 6000h	✕ BX	9318416059408	1	-	25
MELSBUG20BC	20W B22 yellow 5000K 6000h	✕ BX	9318416059415	1	-	25
CFL party light ultra violet - Nelson						
MELS20BLKBC	20W E27 black ultra violet 5000K 6000h	✕ BX	9318416059439	1	4	40
MELS20BLKES	20W B22 black ultra violet 5000K 6000h	✕ BX	9318416059422	1	4	40



New product



Energy Saving products



More info available. See technical pages



Coming soon



Product to be discontinued



Product only available in New Zealand

CS = Clam Shell, BL = Blister pack, BX = Box, SL = Sleeve, HSL = Hang sell sleeve, HBG = Hang sell bag, HBX = Hang sell box, TG = Tag. For more details on packaging see page 4.

Lighting and sensors

Fluorescent globes



MELST215BC



MELMR11ESNS



M5R22CC

Cat.Nos		Pack	Barcode	Single qty	Inner qty	Outer qty
CFL T2 - Nelson						
Edison E27						
MELST211ESN	11W E27 natural white 5000K 8000h twister tube 835 lm	<input type="checkbox"/> BX	9318416072056	1	-	100
MELST215ES	15W E27 warm white 3000K 8000h twister tube 1032 lm	<input type="checkbox"/> BX	9318416072087	1	20	100
MELST215ESN	15W E27 natural white 5000K 8000h twister tube 1032 lm	<input type="checkbox"/> BX	9318416072094	1	20	100
Bayonet B22						
MELST215BC	15W B22 warm white 3000K 8000h twister tube 1032 lm	<input type="checkbox"/> BX	9318416072100	1	20	100
CFL R80 - Nelson						
Edison E27						
MELMR11ESNS	11W E27 natural white 5000K 6000h	BX	9318416054021	1	-	50
Fluorescent T5 lamps - Nelson						
Straight						
M5T14CC	14W cool white 4000K 549mm 12000h	BX	9318416063337	1	-	50
M5T14LC	14W warm white 3000K 549mm 12000h	<input type="checkbox"/> BX	9318416063320	1	-	50
M5T14NC	14W natural white 5000K 549mm 12000h	<input type="checkbox"/> BX	9318416063344	1	-	50
M5T21CC	21W cool white 4000K 549mm 12000h	<input type="checkbox"/> BX	9318416063368	1	-	50
M5T28CC	28W cool white 4000K 549mm 20000h	BX	9318416057985	1	-	50
M5T28D	28W daylight white 6700K 549mm 20000h	<input type="checkbox"/> BX	9318416070724	1	-	50
M5T28NC	28W natural white 5000K 549mm 20000h	<input type="checkbox"/> BX	9318416057992	1	-	50
M5T35NC	35W natural white 5000K 549mm 20000h	<input type="checkbox"/> BX	9318416071264	1	-	25
Circular						
M5R22CC	22W cool white 4000K Ø180mm 16000h	BX	9318416057244	1	-	40
M5R22LC	22W warm white 3000K Ø180mm 16000h	<input type="checkbox"/> BX	9318416060428	1	-	40
M5R22NC	22W natural white 5000K Ø180mm 16000h	BX	9318416059453	1	-	40
M5R32CC	32W cool white 4000K Ø180mm 16000h	BX	9318416060404	1	-	20
M5R32NC	32W natural white 5000K Ø180mm 16000h	BX	9318416060398	1	-	20
M5R40CC	40W cool white 4000K Ø180mm 16000h	BX	9318416064181	1	-	30
M5R40NC	40W natural white 5000K Ø180mm 16000h	BX	9318416064174	1	-	30
Fluorescent T8 lamps - Nelson/NEC/HPM						
Straight - yellow - Nelson						
MCC18Y	18W yellow 7000h	<input type="checkbox"/> BX	9318416063689	1	-	25
MCC36Y	36W yellow 10000h	<input type="checkbox"/> BX	9318416063726	1	-	25

New product

Energy Saving products

More info available. See technical pages

Coming soon

Product to be discontinued

Product only available in New Zealand

CS = Clam Shell, BL = Blister pack, BX = Box, SL = Sleeve, HSL = Hang sell sleeve, HBG = Hang sell bag, HBX = Hang sell box, TG = Tag. For more details on packaging see page 4.

Lighting and sensors

Fluorescent T8 lamps and circular lamps



MG40HG



MI20



MR32CX

Cat.Nos	Fluorescent T8 lamps - Nelson/NEC/HPM	Pack	Barcode	Single qty	Inner qty	Outer qty
	Straight - meat/pink - HPM					
MG30HG	30W meat/pink 880 lm 900mm N	BX	9321001463795	1	-	25
MG40HG	37W meat/pink 1120 lm 1200mm N	BX	9321001463801	1	-	25
MG58HG	58W meat/pink 1760 lm 1510mm N	BX	9321001463818	1	-	25
	Straight - black-insect - NEC					
MI15	15W black/insect 2.1uva 7500h	BX	4904323609611	1	25	200
MI20	20W black/insect 5uva 9000h	BX	4904323609284	1	-	25
MI40	40W black/insect 8uva 20000h	BX	4904323609628	1	-	25
	Straight - blue- NEC					
MJ40	40W blue 7.4uva 20000h	BX	4904323609680	1	10	40
	Fluorescent T9 lamps - Nelson/NEC					
	Circular - Nelson					
MRN22	22W natural white 5000K 9000h	BX	9318416066178	1	-	20
MRN32	32W natural white 5000K 9000h	BX	9318416066185	1	-	20
	Circular - NEC					
MRN22CX	22W cool white 4000K 9000h quad phosphor x	BX	9318416074272	1	-	12
MR20CX	22W cool white 4200K 9000h quad phosphor	BX	4904323624607	1	-	12
MR20X	22W natural white 5000K 9000h quad phosphor	BX	4904323624614	1	-	12
MU22	22W daylight white 6500K 9000h x	BX	4904323609871	1	-	20
MRN32CX	32W cool white 4000K 9000h quad phosphor x	BX	9318416074296	1	-	12
MR32CSG	32W cool white 4200K 9000h	BX	4904323624638	1	-	20
MR32CX	32W cool white 4200K 9000h quad phosphor	BX	4904323624645	1	-	12
MR32SG	32W natural white 5000K 9000h	BX	4904323624652	1	-	20
MR32X	32W natural white 5000K 9000h quad phosphor	BX	4904323624669	1	12	-
MRN32NX	32W natural white 5000K 9000h quad phosphor x	BX	9318416074289	1	-	12
MR32LX	32W warm white 3000K 9000h quad phosphor x	BX	4904323613656	1	-	20
MRN32LX	32W warm white 3000K 9000h quad phosphor x	BX	9318416074302	1	-	12
MR40CX	40W cool white 4200K 9000h quad phosphor	BX	4904323624676	1	-	12
	Fluorescent T8 lamps					
	Straight - Nelson					
MT18C	18W cool white 4200K 12000h	BX	9318416062750	1	-	25
MT18D	18W daylight white 6700K 12000h	BX	9318416063412	1	-	25
MT18NX	18W natural white 5000K 9000h x	BX	9318416074333	1	-	25

N New product

ECO Energy Saving products

+ More info available. See technical pages

COMING SOON Coming soon

x Product to be discontinued

NZ Product only available in New Zealand

CS = Clam Shell, BL = Blister pack, BX = Box, SL = Sleeve, HSL = Hang sell sleeve, HBG = Hang sell bag, HBX = Hang sell box, TG = Tag. For more details on packaging see page 4.

Lighting and sensors

Fluorescent T8 lamps and circular lamps



MT36N



MC10



MT18CX

Cat.Nos	Fluorescent T8 lamps	Pack	Barcode	Single qty	Inner qty	Outer qty
MT18LX	18W warm white 3000K 9000h	BX	9318416074357	1	-	25
MT36C	36W cool white 4200K 12000h	BX	9318416062743	1	-	25
MT36CX	36W cool white	BX	9318416074371	1	-	25
MT36D	36W daylight white 6700K 12000h	BX	9318416063429	1	-	25
MT36N	36W natural white 5000K 12000h	BX	9318416062729	1	-	25
MT36NX	36W natural white 5000K 7500h	BX	9318416074364	1	-	25
Straight - NEC						
MC08	8W cool white 4200K 6000h	BX	4904323609475	1	-	250
MT08HG	8W natural white 5000K 7500h	BX	4904323615940			
MC10	10W cool white 4200K 6000h	BX	4904323609482	1	-	200
MT10HGX	10W natural white 5000K 7500h	BX	4904323617746	1	-	200
MC13	13W cool white 4200K 7500h	BX	4904323609499	1	25	25
MT13HG	13W natural white 5000K 7500h	BX	4904323615957	1	-	25
MC15	15W cool white 4200K 7500h	BX	4904323609512	1	-	25
MT15HGX	15W natural white 5000K 7500h	BX	4904323617722	1	25	200
MT18CX	18W cool white 4200K	BX	9318416074340	1	-	25
MT18CHGX	18W cool white 4200K 9000h	BX	4904323615964	1	-	25
MT18HG	18W natural white 5000K 9000h	BX	4904323609239	1	-	25
MT18HGX	18W natural white 5000K 9000h	BX	4904323615971	1	-	25
MC37SDM	37W cool white 4200K 20000h medical	BX	4904323609574	1	-	25
MT37CHGX	37W cool white 4200K 20000h	BX	4904323615995	1	-	25
MT37DHG	37W daylight white 6500K 20000h	BX	-	1	-	25
MT37DHGSP	37W daylight white 6500K 20000h	BX	-	1	-	25
MT37HG	37W natural white 5000K 20000h	BX	4904323609208	1	-	25
MT37HGSP	37W natural white 5000K 20000h	BX	-	1	-	25
MT37HGX	37W natural white 5000K 20000h	BX	4904323616008	1	-	25
Fluorescent T8 lamps - Nelson/NEC						
Circular - Nelson						
MRN40	40W natural white 5000K 9000h	BX	9318416066192	1	-	10
Circular - NEC						
MR40X	40W natural white 5000K 9000h quad phosphor	BX	4904323624690	1	-	12
MRN40CX	40W cool white 4000K 9000h quad phosphor	BX	9318416074326	1	-	12

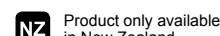
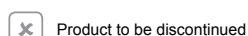
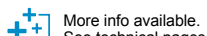

CS = Clam Shell, BL = Blister pack, BX = Box, SL = Sleeve, HSL = Hang sell sleeve, HBG = Hang sell bag, HBX = Hang sell box, TG = Tag. For more details on packaging see page 4.

Lighting and sensors

Ehalogen globes



MNCAN28SESF



MNFRD28ESC



MNG933



MNGU1040

Cat.Nos	Ehalogen candle - Nelson	Pack	Barcode	Single qty	Inner qty	Outer qty
	Edison E14/E27					
MNCAN28SESF	28W E14 frost warm white 2780K	BX	9318416073664	1	10	100
MNCAN28ESC	28W E27 clear warm white 2780K	BX	9318416072339	1	20	100
MNCAN28ESF	28W E27 frost warm white 2780K	BX	9318416073640	1	10	100
MNCAN28SESC	28W E27 clear warm white 2780K	BX	9318416072384	1	-	100
	Bayonet B15/B22					
MNCAN28SBCF	28W B15 frost warm white 2780K	BX	9318416073657	1	10	100
MNCAN28BCC	28W B22 clear warm white 2780K	BX	9318416072223	1	20	100
MNCAN28BCF	28W B22 frost warm white 2780K	BX	9318416073633	1	10	100
MNCAN28SBCC	28W B22 clear warm white 2780K	BX	9318416072360	1	20	100
	Ehalogen fancy round - Nelson					
	Edison E14/E27					
MNFRD28SESC	28W E14 clear warm white 2780K	BX	9318416072377	1	10	100
MNFRD28SESF	28W E14 frost warm white 2780K	BX	9318416073701	1	10	100
MNFRD28ESC	28W E27 clear warm white 2780K	HBX	9318416072346	1	10	100
MNFRD28ESF	28W E27 frost warm white 2780K	BX	9318416073688	1	10	100
	Bayonet B15/B22					
MNFRD28SBCC	28W B15 clear warm white 2780K	HBX	9318416072353	1	10	100
MNFRD28SBCF	28W B15 frost warm white 2780K	BX	9318416073695	1	10	100
MNFRD28BCC	28W B22 clear warm white 2780K	BX	9318416072322	1	10	100
MNFRD28BCF	28W B22 frost warm white 2780K	BX	9318416073671	1	10	100
	Ehalogen G9					
MNG933	33W clear warm white 2780K	CS	9318416072247	1	20	100
MNG942	42W clear warm white 2780K	CS	9318416072254	1	20	200
	Ehalogen GU10- Nelson					
MNGU1040	40W clear warm white 2780K	BX	9318416072261	1	20	200
	Ehalogen GLS - Nelson					
	Edison E27					
MNGLS28ESC	28W E27 clear warm white 2780K	BX	9318416072278	1	10	100
MNGLS28ESF	28W E27 frost warm white 2780K	BX	9318416073725	1	10	100
MNGLS42ESC	42W E27 clear warm white 2780K	BX	9318416072285	1	10	100

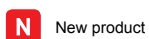

New product



Energy Saving products



More info available. See technical pages



Coming soon



Product to be discontinued



Product only available in New Zealand

CS = Clam Shell, BL = Blister pack, BX = Box, SL = Sleeve, HSL = Hang sell sleeve, HBG = Hang sell bag, HBX = Hang sell box, TG = Tag. For more details on packaging see page 4.

Lighting and sensors

Ehalogen and halogen globes



MNR6342



MJC20CDP

Cat.Nos	Ehalogen GLS - Nelson	Pack	Barcode	Single qty	Inner qty	Outer qty
MNGLS42ESF	42W E27 frost warm white 2780K	BX	9318416073749	1	10	100
MNGLS52ESC	52W E27 clear warm white 2780K	BX	9318416073558	1	10	100
MNGLS52ESF	52W E27 frost warm white 2780K	BX	9318416073596	1	10	100
MNGLS70ESC	70W E27 clear warm white 2780K	BX	9318416073565	1	10	100
MNGLS70ESF	70W E27 frost warm white 2780K	BX	9318416073602	1	10	100
Bayonet B22						
MNGLS28BCC	28W B22 clear warm white 2780K	BX	9318416072209	1	10	100
MNGLS28BCF	28W B22 frost warm white 2780K	BX	9318416073718	1	10	100
MNGLS42BCC	42W B22 clear warm white 2780K	HBX	9318416072216	1	10	100
MNGLS42BCC2P	42W B22 clear warm white 2780K	BX	9321001434603	1	20	60
MNGLS42BCF	42W B22 frost warm white 2780K	BX	9318416073732	1	10	100
MNGLS52BCC	52W B22 clear warm white 2780K	BX	9318416073572	1	10	100
MNGLS52BCF	52W B22 frost warm white 2780K	BX	9318416073619	1	10	100
MNGLS70BCC	70W B22 clear warm white 2780K	BX	9318416073589	1	10	100
MNGLS70BCF	70W B22 frost warm white 2780K	BX	9318416073626	1	10	100
MNR6342	Ehalogen R63 - Nelson 42W clear warm white 2780K	BX	9318416072230	1	10	100
Halogen G4 Bipin - Nelson						
MJC1035	10W G4 clear warm white 3500K	BX	9318416054878	1	-	200
MJC2035	20W G4 clear warm white 3500K	BX	9318416054885	1	-	200
MJC20CDP	20W G4 clear warm white 3500K twin pack	BX	9318416999285	2	-	200
MJC35CDP	35W G4 clear warm white 3500K twin pack	BX	9318416999292	2	-	200
Halogen G9 lamps dimmable - Nelson						
MAG940C	40W clear warm white 3200K dimmable	BX	9318416056636	1	10	200
MAG940F	40W frost warm white 3000K dimmable	BX	9318416056681	1	20	200
MAG9100C	100W clear warm white 3200K dimmable	BX	9318416059231	1	20	200
MAG9100F	100W frost warm white 3000K dimmable	BX	9318416059248	1	20	200
MAG940FX	40W frost Xenon warm white 2900K dimmable	BX	9318416060947	1	10	200
MAG950C	50W clear warm white 3200K dimmable	HBX	9318416056643	1	20	200
MAG975C	75W clear warm white 3200K dimmable	CS	9318416056667	1	20	200
MAG975F	75W frost warm white 3000K dimmable	CS	9318416056711	1	20	200

New product

Energy Saving products

More info available. See technical pages

Coming soon

Product to be discontinued

Product only available in New Zealand

CS = Clam Shell, BL = Blister pack, BX = Box, SL = Sleeve, HSL = Hang sell sleeve, HBG = Hang sell bag, HBX = Hang sell box, TG = Tag. For more details on packaging see page 4.

Lighting and sensors

Halogen lamps



MGU1040G



MAFTDBPB



MABABRPB



MABABYPB



MAFXNCPB

Cat.Nos	Halogen GU10 lamps - Nelson		Pack	Barcode	Single qty	Inner qty	Outer qty
MGU1040	50W clear aluminium reflector	✕	BX	9318416022655	1	10	200
MGU1040E	50W clear aluminium reflector	✕	BX	9318416057237	1	10	100
MGU1040G	50W green aluminium reflector	✕	BX	9318416058555	1	10	200
MGU1040R	50W red aluminium reflector	✕	BX	9318416058548	1	10	200
Halogen MR8 lamps - Nelson							
MAMR820CPB	20W clear aluminium reflector		BX	9318416059149	1	10	200
MAMR8CPB	10W clear aluminium reflector		BX	9318416057398	1	10	200
Halogen MR11 lamps - Nelson							
MAFTD	20W clear aluminium reflector	✕	BX	9318416040314	1	10	200
MAFTDBPB	20W blue aluminium reflector	✕	BX	9318416057411	1	10	200
MAFTDCPB	20W clear aluminium reflector 460cd		BX	9318416057404	1	10	200
MAFTDGPB	20W green aluminium reflector	✕	BX	9318416057428	1	10	200
MAFTDRPB	20W red aluminium reflector		BX	9318416057435	1	10	200
MAFTECPB	35W clear aluminium reflector	✕	BX	9318416067403	1	10	200
Halogen MR16 lamps - Nelson							
MATEN38CPB	10W clear aluminium reflector		BX	9318416070182	1	10	200
MABABBPB	20W blue aluminium reflector		BX	9318416054922	1	10	200
MABABCPB	20W clear aluminium reflector		BX	9318416054908	1	10	200
MABABGPB	20W green aluminium reflector		BX	9318416054946	1	10	200
MABABRPB	20W red aluminium reflector		BX	9318416054939	1	10	200
MABABYPB	20W yellow aluminium reflector		BX	9318416054953	1	10	200
MAFTD2P	20W clear aluminium reflector twin pack		BX	9318416075088	2	10	100
MAFTE	35W clear aluminium reflector	✕	BX	9318416040321	1	10	200
MAFXNBPB	35W blue aluminium reflector	✕	BX	9318416074890	1	10	200
MAFXNCPB	35W clear aluminium reflector	✕	BX	9318416074906	1	10	200
MAWFLC4P	35W clear aluminium reflector 4pack		BX	9318416071622	4	0	100
MAFXTRBG	35W blue/red/green	✕	BX	9318416074968	1	10	200

Lighting and sensors

Halogen lamps & incandescent globes



MQ1LC



MP2050



MP3880



MXR6340ES

Cat. Nos		Pack	Barcode	Single qty	Inner qty	Outer qty
Tungsten halogen R75 - Nelson						
MQ1LC	100W J type clear linear	BX	9318416066413	1	50	500
MQ01SDP	150W J type clear linear twin pack	BX	9318416069186	2	20	120
MQ05C	500W J type clear linear ✕	BX	9318416067182	1	50	500
MQ05DP	500W J type clear linear twin pack	BX	9318416070229	2	20	120
MQ05C6P	500W J type clear linear 6 pack ✕	BX	9318416074470	6	20	80
Halogen PAR20 - Nelson						
MP2050	50W E27	BX	9318416057251	1	-	100
Incandescent E27 mushroom lamps - Nelson						
MXMUSHR60F	60W E27	BX	9318416072544	1	-	100
Incandescent PAR38 - Nelson						
MP3880	80W E27	BX	9318416012052	1	-	24
MP38120	120W E27	BX	9318416012045	1	-	24
MP38	150W E27	BX	9318416011017	1	-	24
MP38DB	150W E27 twin pack	BX	9318416063177	2	-	24
Incandescent pilot lamps - Nelson						
MXUP25BCC	25W B22 clear ✕	CS	9318416064105	1	5	50
MXUP25ESC	25W E27 clear ✕	CS	9318416064112	1	5	50
MXUP25SESC	25W E14 clear ✕	BX	9318416064136	1	5	50
Incandescent R63 - Nelson						
MXR6340ES	40W E27 clear	BX	9318416022228	1	-	200
MXR6360ES	60W E27 clear ✕	BX	9318416022211	1	-	200
Incandescent R80 lamps - Nelson						
MXR80100ES	100W E27 clear ✕	BX	9318416022594	1	-	100
HL100R80ES	100W R80 ES reflector NZ	BX	9415733011819	1	-	-

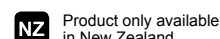
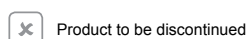
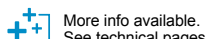
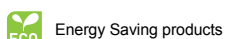

CS = Clam Shell, BL = Blister pack, BX = Box, SL = Sleeve, HSL = Hang sell sleeve, HBG = Hang sell bag, HBX = Hang sell box, TG = Tag. For more details on packaging see page 4.

Lighting and sensors

Flourescent and halogen accessories



CD380



BU366LYWE



366LYWE



LMT0115W

Cat.Nos	Flourescent accessories	Pack	Barcode	Single qty	Inner qty	Outer qty
	Flourescent lampholders					
CD380	White fluorescent tombstone screwed terminals 40 pack	HSB	9321001270959	1	10	400
388	White fluorescent tombstone with spring clips snap-lock term. 40 pack	BX	9321001015123	1	40	680
381	White fluorescent tombstone snap lock terminals 40 pack	BX	9321001014980	1	40	680
	Starter sockets					
CD390	White fluorescent 7/32 diagonal holes screwed term	BX	9321001270966	1	10	400
390	White fluorescent 7/32 diagonal holes screwed term. 40 pack	BX	9321001015758	1	40	960
	Starters					
DF40	White fluorescent 4W to 65W for twin series circuit twin pack	BL	9310539635507	2	10	400
DF20	White universal 4W to 22W for twin fittings twin pack	BX	9310539635408	2	10	400
	Battenholders					
	Adjustable					
D360WE	White B22 adjust. angle 64mm base 50mm mounting centre	PL	9310539250007	1	5	120
	Fixed					
366LYWE	White B22 separate anch. plugs 68mm base 50mm mounting centre	PL	9321001013884	1	10	200
BU366LYWE	White B22 separate anch. plugs 68mm base 50mm mounting centre	PL	9321001407348	1	-	20
366YWE	White B22 integrated anch plugs 68mm base 50mm mounting centre	PL	9321001014034	1	10	200
366WE	White B22 68mm base 50mm mounting centre	PL	9321001013976	1	10	200
366BL	Black B22 68mm base 50mm mounting centre	PL	9321001013693	1	10	200
CD366SWE	Safety White B22 68mm base 50mm mounting centre	PL	9321001270928	1	5	120
CD366WE	White B22 68mm base 50mm mounting centre	PL	9321001270935	1	5	120
366BR	Brown B22 68mm base 50mm mounting centre	PL	9321001013723	1	10	200
360/W1WE	White B22 weatherproof angled 90mm base 50mm mounting centre WP	PL	9321001013488	1	5	100
	Magnetic transformer for MR16LED lamps					
LMT0115W	21W magnetic transformer for MR16 dimmable LED lamps	BX	9321001461999	1	-	20
	Halogen accessories					
WMALCIT	Installation tool for MR16 and GU10 lamps	CS	9318416063085	1	4	40
MAGX5R5P	Leads screw in MR16 5 pack	BL	9318416001308	5	20	200
MAGX5P5P	Leads push in MR16 5 pack	BL	9318416001315	5	20	200
MAGXHT5P	Leads push in hot temperature MR16 5 pack	CS	9318416070397	5	20	200
MTECOUGAR60	60W electronic transformer	HBX	9318416063641	1	-	100
MTECOUG60T	60W electronic transformer 10 pack	BX	9318416074630	10	-	10

Lighting and sensors

Halogen accessories



MTETRADE65



CD333WE



CD310WE



D9500WE



D1001/1

Cat. Nos	Halogen accessories	Pack	Barcode	Single qty	Inner qty	Outer qty
MTECOUGAR60P	60W electronic transformer flex & plug	BX	9318416067199	1	-	50
MTETRADE65	65W electronic transformer	BX	9318416060961	1	-	50
CD9WE	Bayonet cap adaptor	BX	9310539220000	1	10	400
Lampholders						
BC with cord grip						
CD333WE	White BC 4 terminals	HBG	9321001376941	1	10	200
333BL	Black BC 4 terminals	BX	9321001011903	1	10	500
Festoon lampholder						
WS303/1F	Black fanged screw-on cap with WP skirt 50mm mounting centre	BX	9321001206132	1	10	200
D303F	Black fanged screw-on cap with WP skirt 50mm mounting centre	BL	9310539264011			
Lampholder skirts						
CD333SKWE	White BC with cord grip long skirt weatherproof	BX	9321001270904	1	10	200
CD310WE	White 2P pushbar sw. 1/2" brass thread top entry		9321001270898	1	10	200
310/10WE	White double pole pushbar switch 10mm thread top entry	BX	9321001010692	1	10	200
Tapered cap						
359/10WE	White 10mm thread top cable entry	PL	9321001013013	1	10	500
D332WE	Bayonet Safety Lampholder With Cord Grip	BL	9310539265506	1	10	200
D359WE	Bayonet Lampholder Tapered Cap Top Entry	BL	9310539263304	1	10	200
Lamp shade						
D9500WE	Canopy light plug-in w safety lampholder 0.5m lead white	BL	9310539275604	1	5	30
361LS	Coolie lamp shade white	BL	9415733009601	1	10	50
Night light						
D1001/1	Plug-in green moonglow white	CS	9321001150237	1	5	60
Ceiling roses						
Latching cover						
80WE	White 68mm mounting base 4 terminals	PL	9321001053750	1	10	200
Screw on cover						
84WE	White 65mm base 4 plates 2 post per plate	PL	9321001053972	1	10	200
CD84WE	Ceiling rose, screw on cover 10A 250V a.c. white	PL	9321001271208	1	10	200
Testers						
TV7IN1	AC-DV Voltage tester	BL	9318416058401	1	-	100
TVPROX240	AC Voltage tester	BL	9318416058395	1	5	100

Lighting and sensors

Motion sensors



630R01WE



630S01BL



630S01WE



630SM01BL



630/3



630/9-3W

Cat.Nos	360° Recessed Sensor	Pack	Barcode	Single qty	Inner qty	Outer qty
630R01WE	PIR white recessed 300-800W auto-mode 360° scan 6m range	BX	9321001456797	1		
630R02WE	PIR white recessed 250-1000W auto-mode 360° scan 8m range	BX	9321001456803	1	-	24
630S02WE	PIR white surface 250-1000W auto-mode 360° scan 8m range	BX	9321001456803	1		
IP44 Sensors						
630S01WE	PIR white IP44 wall 300-1200W auto 180° scan 12m range N	BX	9321001456773	1		50
630S01BL	PIR black IP44 wall 300-1200W auto 180° scan 12m range N	BX	9321001463658	1		50
630SM01WE	PIR white IP44 wall 300-1200W manual override 180° scan 12m range N	BX	9321001456780	1		50
630SM01BL	PIR black IP44 wall 300-1200W manual override 180° scan 12m range N	BX	9321001463665	1		50
630/3	PIR white IP44 wall 450-1200W manual override 180° scan 12m range					
630/3A	PIR white IP44 wall 450-1200W auto 180° scan 12m range	BX	9310539016412	1	5	40
630/3ABL	PIR black IP44 wall 450-1200W auto 180° scan 12m range	BX	9310539016412	1	5	40
IP44 Sensors - Nelson						
MPES34	PIR white IP44 wall 500-1100W manual override 180° scan 12m range	BX	9318416013011	1	-	40
MPES34B	PIR black IP44 wall 500-1100W manual override 180° scan 12m range	HBX	9318416000943	1	-	50
IP66 Sensors						
630/9-3W	PIR 3-wire white IP66 wall 2400W 110° scan 18m range	BX	9321001272427	1	-	20
IP66 Sensors - Nelson						
MPES66-3W	PIR 3-wire white IP66 wall 2400W 110° scan 18m range	BX	9318416067458	1	-	20



LIGHT UP YOUR STEP
WITH CACTO.

Lighting and sensors

Garden lighting



RGLSSP2



GLLED003



GLLED006



GLLEDPLBL



GLLED005

Cat.Nos	D.I.Y Halogen Garden lighting 12V a.c.	Pack	Barcode	Single qty	Inner qty	Outer qty
	Spotlights					
RGL21	20W spotlight halogen cast aluminium casing black	BX	9321001190233	1	-	4
	Mini Spotlights					
RGLKVSPBL4	5W spotlight halogen polyp. black square inc. transf and cable 4 pack	BX	9321001413578	4	-	16
RGLVSPBL	5W spotlight halogen weatherproof polypropylene black	HBG	9321001413547	1	10	20
RGLKSSM4	10W mini spotlight halogen aluminium IP67 inc. transf and cable 4 pack	BX	9321001244318	4	-	16
RGLSSP2	10W mini spotlight halogen cast aluminium casing satin silver	BX	9321001219156	1	-	6
RGLVSBL	10W mini spotlight halogen metal construction black	BX	9321001413509	1	-	6
RGLKMVBL4	10W spotlight halogen metal black inc. transf and cable 4 pack	BX	9321001413523	4	-	16
RGLAPSP2	20W mini spotlight halogen aluminium and glass casing brushed silver	BX	9321001273035	1	-	6
	Pond Lights					
GL20WMLBL4P	20W halogen 20W black 4 pack	BX	9321001436522	4	-	16
GL20WMLBL	20W halogen black	BX	9321001436539	1	-	20
GL35WPLSS	35W halogen stainless steel	BX	9321001436560	1	-	10
	Bollards and path lights					
RGLVPLB	5W pathlight halogen weatherproof polypropylene IP67 black	BX	9321001413424	1	10	20
RGL3BL2P	10W T-dome uplights halogen metal body black twin pack	BX	9321001413486	2	-	12
RGL1	20W bollard walklight halogen aluminium & glass body verdigris	BX	9321001156420	1	-	4
MGLSSBOL01	Slimline bollard stainless steel bi-pin	BX	9318416066116	1	-	4
	Uplights					
RGLSUP38	20W halogen aluminium body satin silver IP67	BX	9321001201366	1	-	4
	D.I.Y LED Garden lighting 12V a.c.					
	Spotlights					
GLLEDSLSS	1W LED spike spotlight stainless steel	BX	9321001436584	1	3	36
GLLEDSLBL	1W LED spotlight black	BX	9321001436591	1	-	20
RGLSP1M2	1W LED cone spotlight black plastic	BX	9321001417705	1	1	16
GLLED003	1W G4 THE LILO LED geo spotlight IP44 black	BX	9321001474265	1	-	12
GLLED004	3W THE LILO LED spotlight IP55 black	BX	9321001474289	1	-	6
GLLED006	5W THE LILO LED spotlight IP55 black	BX	9321001474326	1	-	20
	Submersible spotlights					
RGLSPS1	1W submersible spotlight LED aluminium casing satin silver IP68 glass diffuser	BX	9321001283263	1	-	6
	Pond Lights					
GLLEDPLBL	1W LED black IP68	BX	9321001436546	1	-	40
GLLED005	3.5W THE TULI LED mini pond spotlight IP68 black	BX	9321001474302	1	-	20
GLLED009	3.5W THE TULI LED mini pond spotlight IP68 4pack black	BX	9321001474388	4	-	16

New product

Energy Saving products

More info available. See technical pages

Coming soon

Product to be discontinued

Product only available in New Zealand

CS = Clam Shell, BL = Blister pack, BX = Box, SL = Sleeve, HSL = Hang sell sleeve, HBG = Hang sell bag, HBX = Hang sell box, TG = Tag. For more details on packaging see page 4.

Lighting and sensors

Garden lighting



GLLED007



GLLED008



RGLLED001

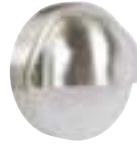

RGLLED002



RGLPCTAW20



RGLTR220

Cat.Nos	D.I.Y LED Garden lighting 12V a.c.		Pack	Barcode	Single qty	Inner qty	Outer qty
GLLED007	4.5W TULI LED pond spotlight IP68 black		BX	9321001474340	1	-	20
GLLED008	4.5W TULI LED pond spotlight IP68 stainless steel		BX	9321001474364	1	-	10
Bollards and path lights							
RGLLED001	1W CACTO LED bollard light stainless steel 304		BX	9321001474227	1	-	6
Wall & steps lights							
RGLSSW1	0.5W wall square LED light aluminium casing satin silver		BX	9321001283249	1	6	24
RGLBW2	0.5W wall round LED light aluminium casing black frosted glass		BX	9321001393078	1	-	16
RGLLED002	1W ROSI LED wall/step light IP54 stainless steel 304		BX	9321001474241	1	-	16
Deck and step lights							
RGLKRSLD24	0.3W deck light LED stainless silver IP67 4 pack		BX	9321001277798	4	6	24
RGLKRSLD4	0.3W deck light LED stainless silver kit 4 lights, transf, cable		BX	9321001273080	4	-	6
RGLKRSLDBL4	0.3W deck light LED stainless steel & plastic silver 4 pack blue light		BX	9321001283171	4	6	24
Transformers							
RGLPCTAW20	10VA black with 12m narrow cable		BX	9321001370710	1	-	6
RGLTR60	60VA self reset therm. overload black IP56		BX	9321001200772	1	-	8
RGLTR105	105VA self reset therm. overload black IP56		BX	9321001200789	1	-	6
RGL11	150VA self reset therm. overload black IP56		BX	9321001163015	1	-	6
RGLTR220	220VA self reset therm. overload black IP56		BX	9321001200796	1	-	4
RGLTR400	400VA self reset therm. overload prot. black IP64		BX	9321001410454	1	-	2
Cable							
CDGLCC4	Cable connector PK4 12V a.c.		SL	9321001385691	1	10	240
RGL8	10m garden cable garden duty black		SL	9321001157168	1	5	20
RGL9	20m garden cable garden duty black		SL	9321001157175	1	5	20
RGLHSC15	15m garden cable standard duty for haloscape black		HSB	9321001259503	1	10	20
RGLCL21/30	30m garden cable extra heavy duty black 2 core 2.08mm		SL	9321001219286	1	-	5
RGLCL33/30	30m garden cable extra heavy duty black 2 core 3.3mm		SL	9321001227915	1	-	5
Timers and sensors							
DGLS150	150W dusk to dawn sensor halogen UV resist plastic IP44 black		BL	9321001201380	1	6	36
RGL10	200W sunset timer automatic UV resistant plastic black		BX	9321001163039	1	-	5
Lamp replacements							
DGLWLED	Replacement globe LED 0.5W 12V a.c. glass transparent twin pack		BL	9321001283294	2	8	32
Solar garden lighting							
Accessories							
DSLBAT4	Solar rechargeable batteries AA NiCd 600mAh yellow 4 pack		BX	9321001256748	4	20	80
DGLHS1	5W halogen globe		BX	9321001248750	1	20	80

New product

Energy Saving products

More info available. See technical pages

Coming soon

Product to be discontinued

Product only available in New Zealand

CS = Clam Shell, BL = Blister pack, BX = Box, SL = Sleeve, HSL = Hang sell sleeve, HBG = Hang sell bag, HBX = Hang sell box, TG = Tag. For more details on packaging see page 4.



SWITCHES & SOCKETS

Switches & sockets



P. 43
Arteor
switches



P. 47
Linea
switches



P. 53
Vivo
switches



P. 58
Excel
switches



P. 63
Standard
switches



P. 65
Como
switches

Weatherproof switches & sockets



P. 66
Aqua
switches

FEATURED PRODUCTS



Arteor
(P. 43)



Linea
(P. 47)



Vivo
(P. 53)



P. 44
Arteor
powerpoints



P. 45
Arteor
mechanisms



P. 45
Arteor
grids



P. 46
Arteor
coverplate



P. 48
Linea
Powerpoints



P. 48
Linea
phone, TV
& data sockets



P. 48
Linea
grids & plates



P. 49
Linea
coverplates
switches



P. 51
Linea
coverplates
powerpoints



P. 55
Vivo
powerpoints

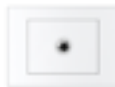

P. 55
Vivo
Phone, TV
& data sockets



P. 56
Vivo
Advanced
functions



P. 56
Vivo
grids



P. 57
Vivo
coverplates &
mechanisms



P. 59
Excel
powerpoints



P. 59
Excel
phone, TV
& data sockets



P. 61
Excel
grids & plates



P. 61
Mechanisms



P. 62
USB, phone,
TV, data &
AV sockets



P. 64
Standard
powerpoints



P. 64
Standard
phone, TV/AV
sockets



P. 65
Como
single powerpoint



P. 65
Como
single powerpoint



P. 66
Aqua
powerpoints



P. 66
Aqua
usb powerpoint



Como
(P. 65)



Aqua
(P. 66)

Switches & sockets solutions



ARTEOR™ DETAILS COUNT

We want you to enjoy a little luxury everyday and flaunt your enviable style. We've scoured the globe to bring you a range of exclusive materials to add that "finishing touch" – transforming the boring to breathtaking. Arteor is a testament to your impeccable eye for detail.



VIVO™ I'M SLEEK & SQUARE, SWITCH TO VIVO

Bold, striking and refreshing – choose the colour for your character. Excel VIVO™ can be customised to suit your taste and your interiors. Keep it simple with traditional rocker switches and white coverplates, or add a designer's edge with the coloured plates to transform your wall from boring to breathtaking



EXCEL THE CLASSIC ALL-ROUNDER

The 80s brought us cassette tapes, hyper-colour, WHAM, shoulder pads, Miami Vice, big hair and the best-selling Excel range of switches & sockets. It was the first range on the market with removable snap-on, snap-off coverplates which made painting easier and allowed people to mix and match coverplate colours according to decor. Cassette tapes are long gone, hair spray sales have plummeted, but Excel has prevailed. Classic design endures.



AQUA™ I'M WEATHERPROOF & ROBUST, SWITCH TO AQUA

With a proud Aussie culture of backyard BBQs, outdoor sports and beers by the pool, having reliable outdoor power has always been the standard. Our beloved sunburnt country is famous for its rugged beauty, but electrical goods bear the brunt of this magnificent, yet tough landscape. Our Aqua range of weatherproof switches has been carefully crafted to suit these environments



*HPM manufacture over 4,500 products in its factory in Prestons, NSW.

Arteor

Functions to be installed with Arteor coverplates



CDAR770/1WE



CDAR770/2MGN



CDAR870/1WE



CDAR883/1MGN



CDAR450PMWE



CDAR770/3FLHMGN

Cat.Nos	Vertical switches and dimmers	Pack	Barcode	Single qty	Inner qty	Outer qty
Rocker switches - Single Pole Double Throw (SPDT)						
CDAR770/1WE	Switch 1 gang 2 way 16A 240V a.c. white	HBG	9321001397229	1	5	80
CDAR770/1MGN	Switch 1 gang 2 way 16A 240V a.c. magnesium	HBG	9321001397267	1	5	80
CDAR770/2WE	Switch 2 gang 2 way 16A 240V a.c. white	HBG	9321001397236	1	5	80
CDAR770/2MGN	Switch 2 gang 2 way 16A 240V a.c. magnesium	HBG	9321001397274	1	5	80
CDAR770/3WE	Switch 3 gang 2 way 16A 240V a.c. white	HBG	9321001397243	1	5	80
CDAR770/3MGN	Switch 3 gang 2 way 16A 240V a.c. magnesium	HBG	9321001397281	1	5	80
CDAR770/4WE	Switch 4 gang 2 way 16A 240V a.c. white	HBG	9321001397250	1	5	80
CDAR770/4MGN	Switch 4 gang 2 way 16A 240V a.c. magnesium	HBG	9321001397298	1	5	80
AR770/5WE	Switch 5 gang 2 way 16A 240V a.c. white	PB	9321001450931	1	10	120
AR770/5MGN	Switch 5 gang 2 way 16A 240V a.c. magnesium	PB	9321001451112	1	10	120
AR770/6WE	Switch 6 gang 2 way 16A 240V a.c. white	PB	9321001450962	1	10	120
AR770/6MGN	Switch 6 gang 2 way 16A 240V a.c. magnesium	PB	9321001451143	1	10	120
Push-button switches						
CDAR870/1WE	Switch push-button 1 gang 10A 250V a.c. white	HBG	9321001430186	1	5	-
CDAR870/1MGN	Switch push-button 1 gang 10A 250V a.c. magnesium	HBG	9321001430179	1	5	-
Electronic push-button switches						
CDAR883/1WE	Push-button electronic switch 10A 250V a.c. white	HBG	9321001430209	1	5	-
CDAR883/1MGN	Push-button electronic switch 10A 250V a.c. magnesium	PB	9321001430193			
Push-button dimmer						
CDAR450PWE	Dimmer push-button 1 gang 2 wire 450VA 240V a.c. white	HBG	9321001430308	1	5	-
CDAR450PMGN	Dimmer push-button 1 gang 2 wire 450VA 240V a.c. magnesium	HBG	9321001430292	1	5	-
Engraved switch plates						
CDAR770/3FLHWE	Switch 3 gang 16A 240V a.c. engraved "Fan/Light/Heat" white	HBG	9321001430223	1	5	-
CDAR770/3FLHMGN	Switch 3 gang 16A 240V a.c. engraved "Fan/Light/Heat" magnesium	PB	9321001430216	1	5	-
CDAR770/4FLHWE	Switch 4 gang 16A 240V a.c. engraved "Fan/Light/Heat" white	PB	9321001430247	1	5	-
CDAR770/4FLHMGN	Switch 4 gang 16A 240V a.c. engraved "Fan/Light/Heat" magnesium	PB	9321001430230	1	5	-

Arteor

Functions and mechanics to be installed with Arteor coverplates

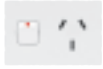

CDAR787WE



CDAR777WE



CDAR777XMGN



CDAR777AWE



CDAR883MMGN

Cat.Nos	Phone, TV, data and AV sockets	Pack	Barcode	Single qty	Inner qty	Outer qty
	Data outlet					
CDAR770/1RJ5EWE	RJ45 outlet Cat 5e 1 gang white	HBG	9321001430315	1	5	-
	Horizontal powerpoints					
	Single powerpoints					
CDAR787WE	Powerpoint 1 gang 10A 240V a.c. white N	HBG	9321001474821	1	5	60
CDAR787MGN	Powerpoint 1 gang 10A 240V a.c. magnesium N	HBG	9321001474838	1	5	60
	Double powerpoints					
CDAR777WE	Powerpoint 2 gang 10A 240V a.c. white	HBG	9321001397182	1	5	80
CDAR777MGN	Powerpoint 2 gang 10A 240V a.c. magnesium	HBG	9321001397199	1	5	80
CDAR777XWE	Powerpoint 2 gang 10A 240V a.c. with extra switch white	HBG	9321001430339	1	5	80
CDAR777XMGN	Powerpoint 2 gang 10A 240V a.c. with extra switch magnesium	HBG	9321001430322	1	5	80
CDAR777AWE	Powerpoint 2 gang 10A 240V a.c. autoswitch white	HBG	9321001397205	1	5	80
CDAR777AMGN	Powerpoint 2 gang 10A 240V a.c. autoswitch magnesium	HBG	9321001397212	1	5	80
	Switch mechanisms					
	Rocker mechanisms					
CDAR770MWE	Switch mech. 2 way 16A 250V a.c. white	HBG	9321001397380	1	5	100
CDAR770MMGN	Switch mech. 2 way 16A 250V a.c. magnesium	HBG	9321001397397	1	5	100
	Push-button mechanisms					
CDAR870MWE	Switch mech. push-button 2 way 10A 250V a.c. white	HBG	9321001397403	1	5	100
CDAR870MMGN	Switch mech. push-button 2 way 10A 250V a.c. magnesium	HBG	9321001397410	1	5	100
CDAR883MWE	Electronic push-button 5A 250V a.c. white	HBG	9321001397427	1	5	100
CDAR883MMGN	Electronic push-button 5A 250V a.c. magnesium	HBG	9321001397434	1	5	100

Arteor

Mechanisms to be installed in Arteor grids



CDAR450PMWE



RAR770USB2PSMWE



CDAR770/1GOWE



CDAR770/2GOMGN



CDAR770/3GOWE



CDAR770/4GOMGN

Cat.Nos		Pack	Barcode	Single qty	Inner qty	Outer qty
Rotary dimmer mechanisms						
Trailing edge						
CDAR400TMWE	Dimmer mech. trailing edge 2 wire 400VA 240V a.c. white	PB	9321001430285	1	5	-
CDAR400TMMGN	Dimmer mech. trailing edge 2 wire 400VA 240V a.c. magnesium	PB	9321001430278	1	5	-
Push-button dimmer mechanisms						
2 wire						
AR400A2PMWE	Dimmer mech. push-button all load 2 wire 400VA 240V a.c. white	PB	9321001431275	1	10	120
AR400A2PMMGN	Dimmer mech. push-button all load 2 wire 400VA 240V a.c. magnesium	PB	9321001431282	1	5	120
CDAR450PMWE	Dimmer mech. push-button 2 wire 450VA 240V a.c. white	HBG	9321001397441	1	5	100
CDAR450PMMGN	Dimmer mech. push-button 2 wire 450VA 240V a.c. magnesium	HBG	9321001397458	1	5	100
3 wire						
AR400A3PMWE	Dimmer mech. push-button all load 3 wire 400VA 240V a.c. white	PB	9321001419471	1	10	120
AR400A3PMMGN	Dimmer mech. push-button all load 3 wire 400VA 240V a.c. magnesium	PB	9321001419501	1	10	120
USB charger mechanisms						
For plasterboard or single brick installations						
RAR770USB2PSMWE	Dual USB charger mech. 2x2.4A 250V a.c. white	HBG	9321001454328	1	5	60
RAR770USB2PSMMG	Dual USB charger mech. 2x2.4A 250V a.c. magnesium	HBG	9321001454335	1	5	60
Grids						
CDAR770/1GOWE	Grid 1 gang white	HBG	9321001397304	1	5	80
CDAR770/1GOMGN	Grid 1 gang magnesium	HBG	9321001397311	1	5	80
CDAR770/2GOWE	Grid 2 gang white	HBG	9321001397328	1	5	80
CDAR770/2GOMGN	Grid 2 gang magnesium	HBG	9321001397335	1	5	80
CDAR770/3GOWE	Grid 3 gang white	HBG	9321001397342	1	5	80
CDAR770/3GOMGN	Grid 3 gang magnesium	HBG	9321001397359	1	5	80
CDAR770/4GOWE	Grid 4 gang white	HBG	9321001397366	1	5	80
CDAR770/4GOMGN	Grid 4 gang magnesium	HBG	9321001397373	1	5	80

New product

More info available. See technical pages

Coming soon

Product to be discontinued

Product only available in New Zealand

Customer Special Order

CS = Clam Shell, BL = Blister pack, BX = Box, SL = Sleeve, HSL = Hang sell sleeve, HBG = Hang sell bag, HBX = Hang sell box, TG = Tag. For more details on packaging see page 4.

Arteor

Coverplates for Arteor functions, grids and mechanisms



CD575430



CD575431



CD575432



CD575434



CD576476



CD575433

Cat.Nos	Coverplates	Pack	Barcode	Single qty	Inner qty	Outer qty
CD575430	Coverplate Arteor white	HBG	9321001397069	1	5	50
CD575431	Coverplate Arteor pearl aluminium ✘	HBG	9321001397076	1	5	50
CD575432	Coverplate Arteor graphite	HBG	9321001397083	1	5	50
CD575433	Coverplate Arteor mirror black	HBG	9321001397137	1	5	50
CD575434	Coverplate Arteor mirror white	HBG	9321001397120	1	5	50
CD575435	Coverplate Arteor wenge wood ✘	HBG	9321001430346	1	5	-
CD575436	Coverplate Arteor stainless steel	HBG	9321001397168	1	5	50
CD576470	Coverplate Arteor gold brass ✘	HBG	9321001397175	1	5	50
CD576471	Coverplate Arteor casual ✘	HBG	9321001397106	1	5	50
CD576472	Coverplate Arteor formal ✘	HBG	9321001397113	1	5	50
CD576475	Coverplate Arteor mirror taupe ✘	HBG	9321001397151	1	5	50
CD576476	Coverplate Arteor mirror red ✘	HBG	9321001397144	1	5	50
CD576478	Coverplate Arteor tattoo ✘	HBG	9321001397090	1	5	50
CD576479	Coverplate Arteor oak ✘	HBG	9321001430353	1	5	-

How to order Arteor



Select a function in white or magnesium (p.43)

+



Select a coverplate (p.46)

=



Complete product!

or



Choose the mechanism in white or magnesium (p.44)

+



Select the grid in white or magnesium (p.45)

+



Select a coverplate (p.46)

=



Complete product!

N New product

++ More info available. See technical pages

COMING SOON Coming soon

✘ Product to be discontinued

NZ Product only available in New Zealand

CSO Customer Special Order

CS = Clam Shell, BL = Blister pack, BX = Box, SL = Sleeve, HSL = Hang sell sleeve, HBG = Hang sell bag, HBX = Hang sell box, TG = Tag. For more details on packaging see page 4.

Linea

Switches – complete product (includes mechanism, grid and plate)



CDLN770/1WEWE



CDLN770/2WEWE



CDLN770/3BLBL



CDLNA770/1WEWE

Cat.Nos	Vertical switches	Pack	Barcode	Single qty	Inner qty	Outer qty
	Rocker switches - Single Pole Double Throw (SPDT)					
CDLN770/1WEWE	Switch 1 gang 2 way 240V a.c. white	HBG	9321001393825	1	5	60
CDLN770/1WEMS	Switch 1 gang 2 way 240V a.c. white/matt silver	HBG	9321001393900	1	5	60
CDLN770/1BLBL	Switch 1 gang 2 way 240V a.c. black	HBG	9321001394082	1	5	60
CDLN770/1BLGL	Switch 1 gang 2 way 240V a.c. black/grey	HBG	9321001393894	1	5	60
CDLN770/2WEWE	Switch 2 gang 2 way 240V a.c. white	HBG	9321001393832	1	5	60
CDLN770/2WEMS	Switch 2 gang 2 way 240V a.c. white/matt silver	HBG	9321001393924	1	5	60
CDLN770/2BLBL	Switch 2 gang 2 way 240V a.c. black	HBG	9321001394105	1	5	60
CDLN770/2BLGL	Switch 2 gang 2 way 240V a.c. black/grey	HBG	9321001393917	1	5	60
CDLN770/3WEWE	Switch 3 gang 2 way 240V a.c. white	HBG	9321001393849	1	5	60
CDLN770/3BLBL	Switch 3 gang 2 way 240V a.c. black	HBG	9321001394129	1	5	60
	Architrave					
	Rocker switches - Single Pole Double Throw (SPDT)					
CDLNA770/1WEWE	Architrave switch 1 gang 2 way 10A 240V a.c. white	HBG	9321001393801	1	5	60
CDLNA770/2WEWE	Architrave switch 2 gang 2 way 10A 240V a.c. white	HBG	9321001393818	1	5	60
	Dimmer mechanisms & fan controllers					
	Dimmers					
CD400TMWE	Rotary dimmer trailing edge 2 wire 400VA 240V a.c. white	BX	9321001416333	1	20	120
CDLN450PWEWE	Push-button dimmer 2 wire 450VA 240V a.c. white	HBG	9321001394136	1	4	60
	Fan controllers					
CD300FMWE	Fan controller rotary 3 speed 300VA 240V a.c. white	BL	9321001416364	1	20	120
	Knobs					
CDKNOB1WE	Dimmer & fan knob white	BL	9321001287490	1	10	240

Linea

Powerpoints, phone, TV and data sockets – complete product (includes mechanism, grid and plate)



CDLN777WEWE



CDLN777LBL



CDLN777BLGL



CDLN777XWEMS



CDLN777AWEWE



CDLN770/2GPLWE

Cat.Nos		Pack	Barcode	Single qty	Inner qty	Outer qty
Horizontal powerpoints						
Single powerpoints						
CDLN787LBL	Powerpoint 1 gang 10A 240V a.c. black	HBG	9321001394167	1	5	60
CDLN787WEWE	Powerpoint 1 gang 10A 240V a.c. white	HBG	9321001394150	1	5	60
Double powerpoints						
CDLN777WEWE	Powerpoint 2 gang 10A 240V a.c. white	HBG	9321001393856	1	5	60
CDLN777WEMS	Powerpoint 2 gang 10A 240V a.c. white/matt silver	HBG	9321001393948	1	5	60
CDLN777LBL	Powerpoint 2 gang 10A 240V a.c. black	HBG	9321001394181	1	5	60
CDLN777BLGL	Powerpoint 2 gang 10A 240V a.c. black/silver	HBG	9321001393931	1	5	60
CDLN777XWEWE	Powerpoint 2 gang 10A 240V a.c. with extra switch white	HBG	9321001393870	1	5	60
CDLN777XWEMS	Powerpoint 2 gang 10A 240V a.c. with extra switch white/silver	HBG	9321001393962	1	5	60
CDLN777XLBL	Powerpoint 2 gang 10A 240V a.c. with extra switch black	HBG	9321001394204	1	5	60
CDLN777XBLGL	Powerpoint 2 gang 10A 240V a.c. with extra switch black/silver	HBG	9321001393955	1	5	60
CDLN777AWEWE	Powerpoint 2 gang 10A 240V a.c. autoswitch white	HBG	9321001393863	1	5	60
TV, phone and data sockets						
CDLN770/1RJ2WE	Data outlet RJ45 1 gang Cat5e white	HBG	9321001393887	1	5	60
CDLN770/1CXWEWE	PAL to saddle TV outlet 1 gang white	HBG	9321001394211	1	5	60
Grid & plates						
Grid & plates only						
CDLN770/1GPLWE	Grid & plate 1 gang white	HBG	9321001397014	1	5	60
CDLN770/2GPLWE	Grid & plate 2 gang white	HBG	9321001397021	1	5	60

Linea

Coverplates



LN770/0PLOG



CDLN770/1PLWE



CDLN770/1PLMS



CDLN770/1PLAS

Cat.Nos	Coverplates	Pack	Barcode	Single qty	Inner qty	Outer qty
Coverplates - Blank						
LN770/0PLWE	Coverplate blank white	CS0 PB	9321001262404	1	10	160
LN770/0PLBL	Coverplate blank black	CS0 PB	9321001262428	1	10	160
LN770/0PLMS	Coverplate blank matt silver	CS0 PB	9321001267294	1	10	200
LN770/0PLAS	Coverplate blank asphalt	CS0 PB	9321001260035	1	10	200
LN770/0PLGL	Coverplate blank gun metal	CS0 PB	9321001289531	1	10	200
LN770/0PLVA	Coverplate blank runaway bride	CS0 PB	9321001379645	1	10	200
LN770/0PLLG	Coverplate blank ghost gum	CS0 PB	9321001380061	1	10	200
LN770/0PLOL	Coverplate blank 5 o'clock olive	CS0 PB	9321001380481	1	10	200
LN770/0PLKH	Coverplate blank ninja khaki	CS0 PB	9321001380900	1	10	200
LN770/0PLDG	Coverplate blank wet elephant	CS0 PB	9321001381327	1	10	200
LN770/0PLMI	Coverplate blank midnight dash	CS0 PB	9321001381747	1	10	200
LN770/0PLYE	Coverplate blank sunshine	CS0 PB	9321001383420	1	10	200
LN770/0PLOG	Coverplate blank orange crush	CS0 PB	9321001382584	1	10	200
LN770/0PLPI	Coverplate blank bubblegum	CS0 PB	9321001384267	1	10	200
LN770/0PLRE	Coverplate blank saucy red	CS0 PB	9321001383000	1	10	200
LN770/0PLSB	Coverplate blank cheeky boy blue	CS0 PB	9321001383840	1	10	200
LN770/0PLAU	Coverplate blank abracadabra	CS0 PB	9321001382164	1	10	200
Coverplates - 1 gang						
CDLN770/1PLWE	Coverplate 1 gang white	HBG	9321001396994	1	5	60
CDLN770/1PLBL	Coverplate 1 gang black	HBG	9321001397007	1	5	60
CDLN770/1PLMS	Coverplate 1 gang matt silver	HBG	9321001293750	1	5	60
CDLN770/1PLAS	Coverplate 1 gang asphalt	HBG	9321001396697	1	5	60
CDLN770/1PLGL	Coverplate 1 gang gun metal	HBG	9321001394259	1	5	60
CDLN770/1PLOL	Coverplate 1 gang 5 o'clock olive	HBG	9321001396857	1	5	60
CDLN770/1PLKH	Coverplate 1 gang ninja khaki	HBG	9321001394273	1	5	60
CDLN770/1PLYE	Coverplate 1 gang sunshine	HBG	9321001396840	1	5	60
LN770/1PLVA	Coverplate 1 gang runaway bride	CS0 PB	9321001379676	1	10	200
LN770/1PLLG	Coverplate 1 gang ghost gum	CS0 PB	9321001380092	1	10	200
LN770/1PLDG	Coverplate 1 gang wet elephant	CS0 PB	9321001381358	1	10	200
LN770/1PLMI	Coverplate 1 gang midnight dash	CS0 PB	9321001381778	1	10	200

N New product

++ More info available. See technical pages

COMING SOON Coming soon

X Product to be discontinued

NZ Product only available in New Zealand

CS0 Customer Special Order

CS = Clam Shell, BL = Blister pack, BX = Box, SL = Sleeve, HSL = Hang sell sleeve, HBG = Hang sell bag, HBX = Hang sell box, TG = Tag. For more details on packaging see page 4.



CDLN770/2PLGL



CDLN770/2PLAS



CDLN770/3PLOL

Cat.Nos	Coverplates	Pack	Barcode	Single qty	Inner qty	Outer qty
LN770/1PLOG	Coverplate 1 gang orange crush	PB	9321001382614	1	10	200
LN770/1PLRE	Coverplate 1 gang saucy red	PB	9321001383031	1	10	200
CDLN770/1PLPI	Coverplate 1 gang bubblegum	HBG	9321001396758	1	5	60
CDLN770/1PLSB	Coverplate 1 gang cheeky boy blue	HBG	9321001396741	1	5	60
CDLN770/1PLAU	Coverplate 1 gang abracadabra	HBG	9321001396949	1	5	60
Coverplates - 2 gang						
CDLN770/2PLWE	Coverplate 2 gang white	HBG	9321001397038	1	5	60
CDLN770/2PLBL	Coverplate 2 gang black	HBG	9321001397045	1	5	60
LN770/2PLCR	Coverplate 2 gang cream	PB	9321001262473	1	10	160
CDLN770/2PLMS	Coverplate 2 gang matt silver	HBG	9321001293767	1	5	60
CDLN770/2PLAS	Coverplate 2 gang asphalt	HBG	9321001396703	1	5	60
LN770/2PLVA	Coverplate 2 gang runaway bride	PB	9321001379706	1	10	200
CDLN770/2PLOL	Coverplate 2 gang 5 o'clock olive	HBG	9321001396871	1	5	60
CDLN770/2PLKH	Coverplate 2 gang ninja khaki	HBG	9321001394310	1	5	60
CDLN770/2PLYE	Coverplate 2 gang sunshine	HBG	9321001396864	1	5	60
CDLN770/2PLPI	Coverplate 2 gang bubblegum	HBG	9321001396772	1	5	60
CDLN770/2PLSB	Coverplate 2 gang cheeky boy blue	HBG	9321001396765	1	5	60
CDLN770/2PLAU	Coverplate 2 gang abracadabra	HBG	9321001396956	1	5	60
CDLN770/2PLGL	Coverplate 2 gang gun metal	HBG	9321001394297	1	5	60
LN770/2PLLG	Coverplate 2 gang ghost gum	PB	9321001380122	1	10	200
LN770/2PLDG	Coverplate 2 gang wet elephant	PB	9321001381389	1	10	200
LN770/2PLMI	Coverplate 2 gang midnight dash	PB	9321001381808	1	10	200
LN770/2PLOG	Coverplate 2 gang orange crush	PB	9321001382645	1	10	200
LN770/2PLRE	Coverplate 2 gang saucy red	PB	9321001383062	1	10	200
Coverplates - 3 gang						
LN770/3PLCR	Coverplate 3 gang cream	PB	9321001262503	1	10	160
CDLN770/3PLMS	Coverplate 3 gang matt silver	HBG	9321001293774	1	5	60
CDLN770/3PLAS	Coverplate 3 gang asphalt	HBG	9321001396710	1	5	60
CDLN770/3PLGL	Coverplate 3 gang gun metal	HBG	9321001394297	1	5	60
LN770/3PLWE	Coverplate 3 gang white	PB	9321001262497	1	10	160
LN770/3PLBL	Coverplate 3 gang black	PB	9321001262510	1	10	160
LN770/3PLVA	Coverplate 3 gang runaway bride	PB	9321001379737	1	10	200
LN770/3PLLG	Coverplate 3 gang ghost gum	PB	9321001380153	1	10	200
CDLN770/3PLOL	Coverplate 3 gang 5 o'clock olive	HBG	9321001396895	1	5	60

Linea

Coverplates



CDLN777PLKH



CDLN777PLYE



CDLN777XPLPI



CDLN777XPLSB

Cat.Nos	Coverplates – 3 gang	Pack	Barcode	Single qty	Inner qty	Outer qty
CDLN770/3PLKH	Coverplate 3 gang ninja khaki	HBG	9321001394358	1	5	60
CDLN770/3PLYE	Coverplate 3 gang sunshine	HBG	9321001396888	1	5	60
CDLN770/3PLPI	Coverplate 3 gang bubblegum	HBG	9321001396796	1	5	60
CDLN770/3PLSB	Coverplate 3 gang cheeky boy blue	HBG	9321001396789	1	5	60
CDLN770/3PLAU	Coverplate 3 gang abracadabra	HBG	9321001396963	1	5	60
LN770/3PLDG	Coverplate 3 gang wet elephant	PB	9321001381419	1	10	200
LN770/3PLMI	Coverplate 3 gang midnight dash	PB	9321001381839	1	10	200
LN770/3PLOG	Coverplate 3 gang orange crush	PB	9321001382676	1	10	200
LN770/3PLRE	Coverplate 3 gang saucy red	PB	9321001383093	1	10	200
Coverplates for double powerpoints						
LN777PLWE	Powerpoint coverplate 2 gang white	PB	9321001265856	1	10	160
LN777PLBL	Powerpoint coverplate 2 gang black	PB	9321001265870	1	10	160
CDLN777PLMS	Powerpoint coverplate 2 gang matt silver	HBG	9321001293699	1	5	60
Coverplates for double powerpoints with extra hole						
CDLN777PLMS	Powerpoint coverplate 2 gang matt silver	HBG	9321001293699	1	5	60
CDLN777PLAS	Powerpoint coverplate 2 gang asphalt	HBG	9321001396727	1	5	60
CDLN777PLOL	Powerpoint coverplate 2 gang 5 o'clock olive	HBG	9321001396918	1	5	60
CDLN777PLKH	Powerpoint coverplate 2 gang ninja khaki	HBG	9321001394433	1	5	60
CDLN777PLYE	Powerpoint coverplate 2 gang sunshine	HBG	9321001396901	1	5	60
LN777PLOG	Powerpoint coverplate 2 gang orange crush	PB	9321001382850	1	10	200
LN777PLRE	Powerpoint coverplate 2 gang sunshine	PB	9321001383277	1	10	200
CDLN777PLAU	Powerpoint coverplate 2 gang abracadabra	HBG	9321001396970	1	5	60
LN777PLGL	Powerpoint coverplate 2 gang gun metal	PB	9321001289920	1	10	200
LN777PLVA	Powerpoint coverplate 2 gang runaway bride	PB	9321001379911	1	10	200
LN777PLLG	Powerpoint coverplate 2 gang ghost gum	PB	9321001380337	1	10	200
LN777PLDG	Powerpoint coverplate 2 gang wet elephant	PB	9321001381594	1	10	200
LN777PLMI	Powerpoint coverplate 2 gang midnight dash	PB	9321001382010	1	10	200
CDLN777PLPI	Powerpoint coverplate 2 gang bubblegum	HBG	9321001396819	1	5	60
CDLN777PLSB	Powerpoint coverplate 2 gang cheeky boy blue	HBG	9321001396802	1	5	60
LN777XPLWE	Powerpoint coverplate 2 gang with extra hole white	PB	9321001377955	1	10	200
LN777XPLBL	Powerpoint coverplate 2 gang with extra hole black	PB	9321001378075	1	10	200
CDLN777XPLMS	Powerpoint coverplate 2 gang with extra hole matt silver	HBG	9321001293705	1	5	60

New product

More info available. See technical pages

Coming soon

Product to be discontinued

Product only available in New Zealand

Customer Special Order

CS = Clam Shell, BL = Blister pack, BX = Box, SL = Sleeve, HSL = Hang sell sleeve, HBG = Hang sell bag, HBX = Hang sell box, TG = Tag. For more details on packaging see page 4.



LN777APLMS



LN777APLVA



LN777APLKH



LN777APLOG

Cat.Nos	Coverplates for double powerpoints with extra hole	Pack	Barcode	Single qty	Inner qty	Outer qty
CDLN777XPLAS	Powerpoint coverplate 2 gang with extra hole asphalt	HBG	9321001396734	1	5	60
LN777XPLGL	Powerpoint coverplate 2 gang with extra hole gun metal	CSO PB	9321001289968	1	10	200
LN777XPLVA	Powerpoint coverplate 2 gang with extra hole runaway bride	CSO PB	9321001379942	1	10	200
LN777XPLLG	Powerpoint coverplate 2 gang with extra hole ghost gum	CSO PB	9321001380368	1	10	200
CDLN777XPLOL	Powerpoint coverplate 2 gang with extra hole 5 o'clock olive	HBG	9321001396932	1	5	60
CDLN777XPLKH	Powerpoint coverplate 2 gang with extra hole ninja khaki	HBG	9321001394471	1	5	60
LN777XPLDG	Powerpoint coverplate 2 gang with extra hole wet elephant	ⓧ PB	9321001381624	1	10	200
LN777XPLMI	Powerpoint coverplate 2 gang with extra hole midnight dash	ⓧ PB	9321001382041	1	10	200
CDLN777XPLYE	Powerpoint coverplate 2 gang with extra hole sunshine	HBG	9321001396925	1	5	60
LN777XPLOG	Powerpoint coverplate 2 gang with extra hole orange crush	ⓧ PB	9321001382881	1	10	200
CDLN777XPLPI	Powerpoint coverplate 2 gang with extra hole bubblegum	HBG	9321001396833	1	5	60
LN777XPLRE	Powerpoint coverplate 2 gang with extra hole saucy red	ⓧ PB	9321001383307	1	10	200
CDLN777XPLSB	Powerpoint coverplate 2 gang with extra hole cheeky boy blue	HBG	9321001396826	1	5	60
CDLN777XPLAU	Powerpoint coverplate 2 gang with extra hole abracadabra	HBG	9321001396987	1	5	60

Cat.Nos	Coverplates for autoswitched double powerpoints	Pack	Barcode	Single qty	Inner qty	Outer qty
LN777APLWE	Powerpoint coverplate 2 gang autoswitch white	CSO PB	9321001377986	1	10	200
LN777APLBL	Powerpoint coverplate 2 gang autoswitch black	CSO PB	9321001378105	1	10	200
LN777APLCR	Powerpoint coverplate 2 gang autoswitch cream	ⓧ PB	9321001378136	1	10	200
LN777APLMS	Powerpoint coverplate 2 gang autoswitch matt silver	CSO PB	9321001289395	1	10	200
LN777APLAS	Powerpoint coverplate 2 gang autoswitch asphalt	CSO PB	9321001260684	1	10	200
LN777APLGL	Powerpoint coverplate 2 gang autoswitch gun metal	CSO PB	9321001290018	1	10	200
LN777APLVA	Powerpoint coverplate 2 gang autoswitch runaway bride	CSO PB	9321001379973	1	10	200
LN777APLLG	Powerpoint coverplate 2 gang autoswitch ghost gum	CSO PB	9321001380399	1	10	200
LN777APLOL	Powerpoint coverplate 2 gang autoswitch 5 o'clock olive	CSO PB	9321001380818	1	10	200
LN777APLKH	Powerpoint coverplate 2 gang autoswitch ninja khaki	CSO PB	9321001381235	1	10	200
LN777APLDG	Powerpoint coverplate 2 gang autoswitch wet elephant	CSO PB	9321001381655	1	10	200
LN777APLMI	Powerpoint coverplate 2 gang autoswitch midnight dash	CSO PB	9321001382072	1	10	200
LN777APLOG	Powerpoint coverplate 2 gang autoswitch orange crush	CSO PB	9321001382911	1	10	200
LN777APLYE	Powerpoint coverplate 2 gang autoswitch sunshine	CSO PB	9321001383758	1	10	200
LN777APLPI	Powerpoint coverplate 2 gang autoswitch bubblegum	CSO PB	9321001384595	1	10	200
LN777APLRE	Powerpoint coverplate 2 gang autoswitch saucy red	CSO PB	9321001383338	1	10	200
LN777APLSB	Powerpoint coverplate 2 gang autoswitch cheeky boy blue	CSO PB	9321001384175	1	10	200
LN777APLAU	Powerpoint coverplate 2 gang autoswitch abracadabra	CSO PB	9321001382492	1	10	200

Vivo

Switches



EV770/1WE



EV770/2GR



EV770/4WE



EV770/1GMWE



EV770/2GMGR

Cat.Nos	Vertical switches		Pack	Barcode	Single qty	Inner qty	Outer qty
EV770/1WE	Switch 1 gang 2 way 10A 240V a.c. white	N	HBG	9321001465461	1	5	60
EV770/1GR	Switch 1 gang 2 way 10A 240V a.c. grey	N	HBG	9321001465522	1	5	60
BUEV770/1WE	Switch 1 gang 2 way 240V a.c. white 10 Pack	N	HBG	9321001474845	1	-	12
EV770/2WE	Switch 2 gang 2 way 10A 240V a.c. white	N	HBG	9321001465478	1	5	60
EV770/2GR	Switch 2 gang 2 way 10A 240V a.c. grey	N	HBG	9321001465539	1	5	60
EV770/3WE	Switch 3 gang 2 way 10A 240V a.c. white	N	HBG	9321001465485	1	5	60
EV770/3GR	Switch 3 gang 2 way 10A 240V a.c. grey	N	HBG	9321001465546	1	5	60
EV770/4WE	Switch 4 gang 2 way 10A 240V a.c. white	N	HBG	9321001465492	1	5	60
EV770/4GR	Switch 4 gang 2 way 10A 240V a.c. grey	N	HBG	9321001465553	1	5	60
EV770/5WE	Switch 5 gang 2 way 10A 240V a.c. white	N	HBG	9321001465508	1	5	60
EV770/5GR	Switch 5 gang 2 way 10A 240V a.c. grey	N	HBG	9321001465560	1	5	60
EV770/6WE	Switch 6 gang 2 way 10A 240V a.c. white	N	HBG	9321001465515	1	5	60
EV770/6GR	Switch 6 gang 2 way 10A 240V a.c. grey	N	HBG	9321001465577	1	5	60
EV770/1GMWE	Switch 1 gang 2 way 10A 240V a.c. white no coverplate	N	HBG	9321001465676	1	10	120
EV770/1GMGR	Switch 1 gang 2 way 10A 240V a.c. grey no coverplate	N	HBG	9321001465706	1	10	120
EV770/2GMWE	Switch 2 gang 2 way 10A 240V a.c. white no coverplate	N	HBG	9321001465683	1	10	120
EV770/2GMGR	Switch 2 gang 2 way 10A 240V a.c. grey no coverplate	N	HBG	9321001465713	1	10	120
EV770/3GMWE	Switch 3 gang 2 way 10A 240V a.c. white no coverplate	N	HBG	9321001465690	1	10	120
EV770/3GMGR	Switch 3 gang 2 way 10A 240V a.c. grey no coverplate	N	HBG	9321001465720	1	10	120
EV770/4GMWE	Switch 4 gang 2 way 10A 240V a.c. white no coverplate	N	HBG	9321001481539	1	10	120
EV770/4GMGR	Switch 4 gang 2 way 10A 240V a.c. grey no coverplate	N	HBG	9321001481560	1	10	120
EV770/5GMWE	Switch 5 gang 2 way 10A 240V a.c. white no coverplate	N	HBG	9321001481546	1	10	120
EV770/5GMGR	Switch 5 gang 2 way 10A 240V a.c. grey no coverplate	N	HBG	9321001481577	1	10	120
EV770/6GMWE	Switch 6 gang 2 way 10A 240V a.c. white no coverplate	N	HBG	9321001481553	1	10	120
EV770/6GMGR	Switch 6 gang 2 way 10A 240V a.c. grey no coverplate	N	HBG	9321001481584	1	10	120
EV770/40DPWE	Switch 1 gang 2 way 40A 240V a.c. white double pole	N	HBG	9321001465652	1	5	60
EV770/40DPGR	Switch 1 gang 2 way 40A 240V a.c. grey double pole	N	HBG	9321001465669	1	5	60
EV770/3FLHWE	Switch 3 gang 2 way 10A 240V a.c. white no coverplate	N	HBG	9321001465638	1	5	60
EV770/4FLHWE	Switch 4 gang 2 way 10A 240V a.c. white no coverplate	N	HBG	9321001465645	1	5	60

N New product

+ More info available. See technical pages

COMING SOON Coming soon

X Product to be discontinued

NZ Product only available in New Zealand

CSO Customer Special Order

CS = Clam Shell, BL = Blister pack, BX = Box, SL = Sleeve, HSL = Hang sell sleeve, HBG = Hang sell bag, HBX = Hang sell box, TG = Tag. For more details on packaging see page 4.



EV250TWE



EV400PB2GR



EV770/1FCWE



EV787WE



EV787GMGR



EV777XWE

Cat.Nos			Pack	Barcode	Single qty	Inner qty	Outer qty
Vertical switches							
Architrave Switches - Single Pole Double Throw (SPDT)							
EVA770/1WE	Switch 1 gang 2 way 10A 240 A.C. white	N	HBG	9321001465584	1	10	120
EVA770/2WE	Switch 2 gang 2 way 10A 240 A.C. white	N	HBG	9321001465591	1	10	120
EVA770/3WE	Switch 3 gang 2 way 10A 240 A.C. white	N	HBG	9321001465607	1	10	120
Rotary Dimmers							
EV250TWE	Rotary dimmer trailing edge 2 wire 250VA 240V a.c. white	N	HBG	9321001465775	1	5	60
EV250TGR	Rotary dimmer trailing edge 2 wire 250VA 240V a.c. grey	N	HBG	9321001465782	1	5	60
Push-button Dimmers							
EV400PB2WE	Push button dimmer all load 2 wire 450VA 240V a.c. white	N	HBG	9321001465737	1	5	60
EV400PB2GR	Push button dimmer all load 2 wire 450VA 240V a.c. grey	N	HBG	9321001465744	1	5	60
EV400PB3WE	Push button dimmer all load 3 wire 450VA 240V a.c. white	N	HBG	9321001465751	1	5	60
EV400PB3GR	Push button dimmer all load 3 wire 450VA 240V a.c. grey	N	HBG	9321001465768	1	5	60
Fan Controllers							
EV770/1FCWE	Fan controller 3 speed 240V a.c. white	N	HBG	9321001465614	1	5	60
EV770/1FCGR	Fan controller 3 speed 240V a.c. grey	N	HBG	9321001465621	1	5	60
Blank plates							
EV770/0WE	Blank plate white	N	HBG	9321001466314	1	10	120
EV770/0GR	Blank plate Grey	N	HBG	9321001466321	1	10	120
Horizontal Powerpoints							
Single Powerpoints							
EV787WE	Powerpoint 1 gang 10A 240V a.c. white	N	HBG	9321001465249	1	10	120
EV787GR	Powerpoint 1 gang 10A 240V a.c. grey	N	HBG	9321001465331	1	10	120
EV787GMWE	Powerpoint 1 gang 10A 240V a.c. white no coverplate	N	HBG	9321001465416	1	10	120
EV787GMGR	Powerpoint 1 gang 10A 240V a.c. grey no coverplate	N	HBG	9321001465447	1	10	120
Double Powerpoints							
EV777WE	Double Powerpoint 2 gang 10A 240V a.c. white	N	HBG	9321001465232	1	10	120
EVBU777WE	Double Powerpoint 2 gang 10A 240V a.c. white 10 pack	N	HBG	9321001465317	10	-	12
EV777GR	Double Powerpoint 2 gang 10A 240V a.c. grey	N	HBG	9321001465324	1	10	120
EV777XWE	Double Powerpoint 2 gang 10A 240V a.c. white with extra switch	N	HBG	9321001465256	1	10	120
EV777XGR	Double Powerpoint 2 gang 10A 240V a.c. grey with extra switch	N	HBG	9321001465348	1	10	120
EV777GMWE	Double Powerpoint 2 gang 10A 240V a.c. white no coverplate	N	HBG	9321001465409	1	10	120

Vivo

Powerpoints



EV777USB2PSAWE



EV777USB2ACGR



EV787WE



EVV777WE



EV770/1CXWE



EV770-1RJ5EWE

Cat.Nos			Pack	Barcode	Single qty	Inner qty	Outer qty
Horizontal Powerpoints							
EV777XGMWE	Double Powerpoint 2 gang 10A 240V a.c. white with extra switch no coverplate	N	HBG	9321001465423	1	10	120
EV777GMGR	Double Powerpoint 2 gang 10A 240V a.c. grey no coverplate	N	HBG	9321001465430	1	10	120
EV777XGMGR	Double Powerpoint 2 gang 10A 240V a.c. white with extra switch no coverplate	N	HBG	9321001465454	1	10	120
EV777USB2IWE	Double Powerpoint 2 gang 10A 240V a.c. white with USB 2.4A	N	HBG	9321001465294	1	5	60
EV777USB2IGR	Double Powerpoint 2 gang 10A 240V a.c. grey with USB 2.4A	N	HBG	9321001465386	1	5	60
EV777USB2PSAWE	Double Powerpoint 2 gang 10A 240V a.c. white with USB 2X2.4A	N	HBG	9321001465300	1	-	12
EV777USB2PSAGR	Double Powerpoint 2 gang 10A 240V a.c. grey with USB 2X2.4A	N	HBG	9321001465393	1	-	12
EV777USB2ACWE	Double Powerpoint 2 gang 10A 240V a.c. white with USB Type A&C 4.8A	N	HBG	9321001469568	1	-	12
EV777USB2ACGR	Double Powerpoint 2 gang 10A 240V a.c. grey with USB Type A&C 4.8A	N	HBG	9321001469575	1	-	12
Vertical Powerpoints							
Single Powerpoints							
EVV787WE	Single Powerpoint Vertical 10A 240V a.c. white	N	HBG	9321001465287	1	10	120
EVV787GR	Single Powerpoint Vertical 10A 240V a.c. grey	N	HBG	9321001465379	1	10	120
Double Powerpoints							
EVV777WE	Double Powerpoint Vertical 10A 240V a.c. white	N	HBG	9321001465263	1	10	120
EVV777GR	Double Powerpoint Vertical 10A 240V a.c. grey	N	HBG	9321001465355	1	10	120
EVV777XWE	Double Powerpoint Vertical 10A 240V a.c. white with extra switch	N	HBG	9321001465270	1	10	120
EVV777XGR	Double Powerpoint Vertical 10A 240V a.c. grey with extra switch	N	HBG	9321001465362	1	10	120
TV and AV Outlets							
EV770/1CXWE	TV outlet coaxial 1 gang 75 Ohm white	N	HBG	9321001465812	1	10	120
EV770/1CXGR	TV outlet coaxial 1 gang 75 Ohm grey	N	HBG	9321001465850	1	10	120
EV770/1FOXWE	Foxtel TV outlet 1 gang 75 Ohm white	N	HBG	9321001465836	1	10	120
EV770/1FOXGR	Foxtel TV outlet 1 gang 75 Ohm grey	N	HBG	9321001465874	1	10	120
Phone & data outlets							
EV770/1RJ5EWE	Phone outlet RJ5 1 gang white	N	HBG	9321001465843	1	10	120
EV770/1RJ5EGR	Phone outlet RJ5 1 gang grey	N	HBG	9321001465881	1	10	120
EV770/1RJ6WE	Phone outlet RJ6 1 gang white	N	HBG	9321001469605	1	10	120
EV770/1RJ6GR	Phone outlet RJ6 1 gang grey	N	HBG	9321001469636	1	10	120
EV770/2RJ5EWE	Phone outlet RJ5 2 gang white	N	HBG	9321001465829	1	10	120
EV770/2RJ5EGR	Phone outlet RJ5 2 gang grey	N	HBG	9321001465867	1	10	120
EV770/2RJ6WE	Phone outlet RJ6 2 gang white	N	HBG	9321001469667	1	10	120
EV770/2RJ6GR	Phone outlet RJ6 2 gang grey	N	HBG	9321001469698	1	10	120

N New product

+ More info available. See technical pages

COMING SOON Coming soon

X Product to be discontinued

NZ Product only available in New Zealand

CSO Customer Special Order

CS = Clam Shell, BL = Blister pack, BX = Box, SL = Sleeve, HSL = Hang sell sleeve, HBG = Hang sell bag, HBX = Hang sell box, TG = Tag. For more details on packaging see page 4.

Vivo

Advanced functions and grids



EV803PIRWE



EVSENSORLIGHTWE



EVHDMIUSBWE



EVBTKWE



EV770/1GOWE

Cat.Nos	Advanced functions		Pack	Barcode	Single qty	Inner qty	Outer qty
EV803PIRWE	PIR sensor white	N	HBG	9321001466338	1	5	60
EV803PIRGR	PIR sensor grey	N	HBG	9321001466345	1	5	60
EVNLIGHTWE	Night light white	N	HBG	9321001466352	1	5	60
EVDWE	Time delay white	N	HBG	9321001466376	1	5	60
EVSLIGHTWE	Skirting light white	N	HBG	9321001466413	1	5	60
EVSENSORLIGHTWE	Skirt light with sensor white	N	HBG	9321001466437	1	5	60
EVSENSORLIGHTGR	Skirt light with sensor grey	N	HBG	9321001466444	1	5	60
EVSHUTTERWE	Shutter Switch Up/Down white	N	HBG	9321001466451	1	5	60
EVHDMIUSBWE	HDMI & USB Socket white	N	HBG	9321001466475	1	5	60
EVHDMIUSBGR	HDMI & USB Socket grey	N	HBG	9321001466482	1	5	60
EVBTKWE	Bluetooth sound kit white (Bluetooth receiver, speakers x2, speaker cable 10mts)	N	HBG	9321001469810	1	-	-
EVBTKGR	Bluetooth sound kit grey (Bluetooth receiver, speakers x2, speaker cable 10mts)	N	HBG	9321001469827	1	-	-
EVWPADMS	Wireless Charging Station 80mm silver	N	HBG	9321001474531	1	-	10
	Grids						
EV770/1GOWE	1 gang grid only white	N	HBG	9321001465898	1	10	120
EV770/1GOGR	1 gang grid only grey	N	HBG	9321001465928	1	10	120
EV770/2GOWE	2 gang grid only white	N	HBG	9321001465904	1	10	120
EV770/2GOGR	2 gang grid only grey	N	HBG	9321001465935	1	10	120
EV770/3GOWE	3 gang grid only white	N	HBG	9321001465911	1	10	120
EV770/3GOGR	3 gang grid only grey	N	HBG	9321001465942	1	10	120
EV770/4GOWE	4 gang grid only white	N	HBG	9321001481591	1	10	120
EV770/4GOGR	4 gang grid only grey	N	HBG	9321001481621	1	10	120
EV770/5GOWE	5 gang grid only white	N	HBG	9321001481607	1	10	120
EV770/5GOGR	5 gang grid only grey	N	HBG	9321001481638	1	10	120
EV770/6GOWE	6 gang grid only white	N	HBG	9321001481614	1	10	120
EV770/6GOGR	6 gang grid only grey	N	HBG	9321001481645	1	10	120
	Coverplates (fits all VIVO grids)						
EVPLWE	White gloss coverplate	N	HBG	9321001466109	1	10	120
EVPLGR	Grey gloss coverplate	N	HBG	9321001466116	1	10	120
EVPLLG	Light grey coverplate	N	HBG	9321001466123	1	10	120
EVPLKH	Khaki coverplate	N	HBG	9321001466130	1	10	120
EVPLDG	Dark grey coverplate	N	HBG	9321001466147	1	10	120
EVPLBU	Pop blue coverplate	N	HBG	9321001466154	1	10	120

N New product

+ More info available. See technical pages

COMING SOON Coming soon

X Product to be discontinued

NZ Product only available in New Zealand

CSO Customer Special Order

CS = Clam Shell, BL = Blister pack, BX = Box, SL = Sleeve, HSL = Hang sell sleeve, HBG = Hang sell bag, HBX = Hang sell box, TG = Tag. For more details on packaging see page 4.

Vivo

Coverplates and mechanisms



EVPLPI



EVPLCO



EVPLRD



EVPLPG



EVM770WE



EVM400A2WE

Cat.Nos	Coverplates (fits all VIVO grids)		Pack	Barcode	Single qty	Inner qty	Outer qty
EVPLPI	Pop pink coverplate	N	HBG	9321001466161	1	10	120
EVPLRD	Bright red coverplate	N	HBG	9321001466178	1	10	120
EVPLMT	Mint coverplate	N	HBG	9321001466185	1	10	120
EVPLMS	Silver coverplate	N	HBG	9321001466192	1	10	120
EVPLCO	Copper coverplate	N	HBG	9321001466208	1	10	120
EVPLBL	Graphite coverplate	N	HBG	9321001466215	1	10	120
EVPLPG	Reflection pink Gold coverplate	N	HBG	9321001466222	1	10	120
EVPLCH	Reflection chrome coverplate	N	HBG	9321001466239	1	10	120
	Mechanisms						
EVM770WE	Switch mech. 10A 240V a.c. white	N	HBG	9321001465959	1	10	120
EVM770GR	Switch mech. 10A 240V a.c. grey	N	HBG	9321001465966	1	10	120
EVM770IMWE	Switch mech. intermediate 10A 240V a.c. white	N	HBG	9321001465973	1	10	120
EVM770IMGR	Switch mech. intermediate 10A 240V a.c. grey	N	HBG	9321001465980	1	10	120
EVM883WE	Push-button switch mechanism white	N	HBG	9321001469124	1	6	72
EVM883GR	Push-button switch mechanism grey	N	HBG	9321001469131	1	6	72
EVM400A2WE	Push-button dimmer mech. 2 wire 400VA 240V a.c. white	N	HBG	9321001469148	1	6	72
EVM400A2GR	Push-button dimmer mech. 2 wire 400VA 240V a.c. grey	N	HBG	9321001469155	1	6	72
EVM400A3WE	Push-button dimmer mech. 3 wire 400VA 240V a.c. white	N	HBG	9321001469162	1	6	72
EVM400A3GR	Push-button dimmer mech. 3 wire 400VA 240V a.c. grey	N	HBG	9321001469179	1	6	72
EVM3FCWE	Fan controller rotary 3 speed 300VA 240V a.c. white	N	HBG	9321001465997	1	10	120
EVMFANKNOBWE	Fan knob white 3 pack	N	HBG	9321001466000	1	10	120
EVMFANKNOBGR	Fan knob grey 3 pack	N	HBG	9321001466017	1	10	120
EVMP5WE	Pal to saddle mechanism white	N	HBG	9321001466024	1	10	120
EVMP5GR	Pal to saddle mechanism grey	N	HBG	9321001469728	1	10	120
EVM770LEDWE	Switch with led ring 10A 240V a.c. white	N	HBG	9321001466031	1	10	120
EVM770LEDGR	Switch with led ring 10A 240V a.c. grey	N	HBG	9321001466048	1	10	120
EVM770TWE	Telephone outlet RJ11 Cat3 white	N	HBG	9321001466055	1	10	120
EVMUSB2PSAWE	USB Charger mech. 2X2.4A 240V a.c. white	N	HBG	9321001466062	1	5	60
EVMUSB2PSAGR	USB Charger mech. 2X2.4A 240V a.c. grey	N	HBG	9321001466079	1	5	60
EVMUSB2ACWE	USB Charger type A&C 4.8A 240V a.c. white	N	HBG	9321001469759	1	5	60
EVMUSB2ACGR	USB Charger type A&C 4.8A 240V a.c. grey	N	HBG	9321001469780	1	5	60
EVMFFOXWE	Pay-TV Foxtel outlet white	N	HBG	9321001466086	1	10	120
EVMFFOXGR	Pay-TV Foxtel outlet grey	N	HBG	9321001466093	1	10	120

N New product

+ More info available. See technical pages

COMING SOON Coming soon

X Product to be discontinued

NZ Product only available in New Zealand

CSO Customer Special Order

CS = Clam Shell, BL = Blister pack, BX = Box, SL = Sleeve, HSL = Hang sell sleeve, HBG = Hang sell bag, HBX = Hang sell box, TG = Tag. For more details on packaging see page 4.



CDXL770/1WEWE



CDXL770/2BLBL



CDXL300FWE



CDXL770/3FLHWE



CDXLA770/1WEWE



XL400TWE

Cat.Nos		Pack	Barcode	Single qty	Inner qty	Outer qty
Vertical switches						
Rocker switches - Single Pole Double Throw (SPDT)						
CDXL770/1WEWE	Switch 1 gang 2 way 10A 240V a.c. white	HBG	9321001274568	1	10	130
CDXL770/1BLBL	Switch 1 gang 2 way 10A 240V a.c. black	HBG	9321001385875	1	10	130
CDXL770/2WEWE	Switch 2 gang 2 way 10A 240V a.c. white	HBG	9321001274575	1	10	130
CDXL770/2BLBL	Switch 2 gang 2 way 10A 240V a.c. black	HBG	9321001385905	1	10	130
CDXL770/3WEWE	Switch 3 gang 2 way 10A 240V a.c. white	HBG	9321001274582	1	10	130
CDXL770/3BLBL	Switch 3 gang 2 way 10A 240V a.c. black	HBG	9321001385936	1	10	200
CDXL770/4WEWE	Switch 4 gang 2 way 10A 240V a.c. white	HBG	9321001393764	1	10	130
CDXL770/5WEWE	Switch 5 gang 2 way 10A 240V a.c. white	HBG	9321001393771	1	10	130
CDXL770/0WE	Grid & plate blank white	HBG	9321001416210	1	10	120
Rocker switches 35A						
CDXL1036WE	Switch 1 gang 2 way 35A 240V a.c. white	HBG	9321001416241	1	10	120
Rotary fan controllers						
CDXL300FWE	Fan controller 300VA white	HBG	9321001171423	1	5	120
Permanent connection unit						
CD770/2PCWE	Perm connection unit white	HBG	9415733000592	1	10	100
Weatherproof switches - Single Pole Double Throw (SPDT)						
CDXLW770V1WE	Switch vertical 2 gang 2 way IP56 10A 240V a.c. white	HBG	9321001171546	1	5	120
Engraved switches - Single Pole Double Throw (SPDT)						
CDXL770/3FLHWE	Switch 3 gang 16A 240V a.c. engraved "Fan/Light/Heat" white	HBG	9321001437437	1	10	120
CDXL770/4FLHHWE	Switch 4 gang 16A 240V a.c. engraved "Fan/Light/Heat/Heat" white	HBG	9321001437444	1	10	120
Architrave						
Rocker switches - Single Pole Double Throw (SPDT)						
CDXLA770/1WEWE	Architrave switch 1 gang 2 way 10A 240V a.c. white	BL	9321001271284	1	10	240
CDXLA770/2WEWE	Architrave switch 2 gang 2 way 10A 240V a.c. white	BL	9321001271291	1	10	240
CDXLA770/3WEWE	Architrave switch 3 gang 2 way 10A 240V a.c. white	BL	9321001274551	1	10	240
Rotary dimmers						
Trailing edge						
XL250TWE	Rotary dimmer trailing edge 2 wire 250VA 240V a.c. white	BX	9321001284000	1	3	108
XL400TWE	Rotary dimmer trailing edge 2 wire 400VA 240V a.c. white	BX	9321001273851	1	3	108

Excel

Powerpoints



CDXL787WEWE



CDXL777XWEWE



RXL777USB2PSWE



CDXL7774WEWE



CDXLV777XWEWE



CDXL770/1FOXWEW

Cat.Nos		Pack	Barcode	Single qty	Inner qty	Outer qty
Horizontal powerpoints						
Single powerpoints						
CDXL787WEWE	Powerpoint 1 gang 10A 240V a.c. white	HBG	9321001274391	1	10	100
CDXL787BLMS	Powerpoint 1 gang 10A 240V a.c. black/matt silver	HBG	9321001274445	1	10	100
CDXL787XWEWE	Powerpoint 1 gang 10A 240V a.c. with extra switch white	HBG	9321001274414	1	10	100
Double powerpoints						
CDXL777WEWE	Powerpoint 2 gang 10A 240V a.c. white	HBG	9321001274407	1	10	120
CDXL777BLBL	Powerpoint 2 gang 10A 240V a.c. black	HBG	9321001386025	1	10	120
BUXL777WE	Powerpoint 2 gang 10A 240V a.c. white 10 pack	BX	9321001407294	10	-	-
CDXL777XWEWE	Powerpoint 2 gang 10A 240V a.c. with extra switch white	HBG	9321001274421	1	10	130
CDXLP777ESWEWE	Powerpoint 2 gang 10A 240V a.c. with extra safety white	HBG	9321001389026	1	10	120
Double powerpoints with USB						
RXL777USB2PSWE	Powerpoint 2 gang 10A 240V a.c. with dual USB charger 2x2.4A white	BX	9321001435068	1	-	12
4 gang powerpoints						
CDXL7774WEWE	Powerpoint 4 gang 10A 240V a.c. white	HBG	9321001274438	1	5	30
RCD powerpoints						
CDXL777EL30	Powerpoint 10A 30mA RCD socket white	NZ HBG	9310539042800	1	3	36
Vertical powerpoints						
Single powerpoints						
CDXLV787WEWE	Powerpoint 1 gang 10A 240V a.c. white	HBG	9321001376538	1	10	200
CDXLV787BLBL	Powerpoint 1 gang 10A 240V a.c. black	NZ HBG	9321001385967	1	10	200
Vertical double powerpoints						
CDXLV777BLBL	Powerpoint 2 gang 10A 240V a.c. black	NZ HBG	9321001386056	1	10	200
CDXLV777WEWE	Powerpoint 2 gang 10A 240V a.c. white	NZ HBG	9321001376569	1	10	120
CDXLV777XWEWE	Powerpoint 2 gang 10A 240V a.c. with extra switch white	NZ HBG	9310539016405	1	10	100
Phone, TV, data and AV sockets						
TV outlets						
CDXL770/1CXWE	TV outlet coaxial 1 gang 75 Ohm white	HBG	9321001139522	1	10	200
CDXL770/1FOXWEW	TV outlet F type Pay TV white	HBG	9321001393795	1	10	120
Data outlets						
CDXL770/1RJ2WEW	RJ45 outlet Cat5e 1 gang white	HBG	9321001393788	1	10	120

N New product

+ More info available. See technical pages

COMING SOON Coming soon

X Product to be discontinued

NZ Product only available in New Zealand

CSO Customer Special Order

CS = Clam Shell, BL = Blister pack, BX = Box, SL = Sleeve, HSL = Hang sell sleeve, HBG = Hang sell bag, HBX = Hang sell box, TG = Tag. For more details on packaging see page 4.

Excel

Coverplates



CDXL770/1PLWE



CDXL770/2PLPB



CDXL770/3PLMS



CDXL787PLWE



CDXL777PLWE



CDXL777XPLWE

Cat.Nos	Switch coverplates	Pack	Barcode	Single qty	Inner qty	Outer qty
Switch coverplates – 1 gang						
CDXL770/1PLWE	Coverplate 1 gang white	HBG	9321001134664	1	10	400
CDXL770/1PLPB	Coverplate 1 gang polished brass	HBG	9321001134787	1	10	400
CDXL770/1PLMS	Coverplate 1 gang matt silver	HBG	9321001134794	1	10	400
CDXL770/1PLSS	Coverplate 1 gang stainless steel	HBG	9321001261124	1	10	400
Switch coverplates – 2 gang						
CDXL770/2PLWE	Coverplate 2 gang white	HBG	9321001134695	1	10	400
CDXL770/2PLPB	Coverplate 2 gang polished brass	HBG	9321001134817	1	10	400
CDXL770/2PLMS	Coverplate 2 gang matt silver	HBG	9321001134824	1	10	400
CDXL770/2PLSS	Coverplate 2 gang stainless steel	HBG	9321001261186	1	10	400
Switch coverplates – 3 gang						
CDXL770/3PLWE	Coverplate 3 gang gloss white	HBG	9321001431640	1	10	320
CDXL770/3PLMS	Coverplate 3 gang matt silver	HBG	9321001413103	1	10	400
Powerpoints coverplates						
Single powerpoint coverplates						
CDXL787PLWE	Powerpoint coverplate 1 gang white	HBG	9321001134725	1	10	400
CDXL787PLMS	Powerpoint coverplate 1 gang matt silver	HBG	9321001134855	1	10	400
CDXL787PLPB	Powerpoint coverplate 1 gang polished brass	HBG	9321001134848	1	10	400
CDXL787PLSS	Powerpoint coverplate 1 gang stainless steel	HBG	9321001261513	1	10	400
CDXLV787PLMS	Powerpoint vertical coverplate 1 gang matt silver	NZ HBG	9321001394044	1	10	120
CDXLV787PLWE	Powerpoint vertical coverplate 1 gang white	NZ HBG	9321001394068	1	10	120
Double powerpoints coverplates						
CDXL777PLWE	Powerpoint coverplate 2 gang white	HBG	9321001134756	1	10	400
CDXL777PLMS	Powerpoint coverplate 2 gang matt silver	HBG	9321001134886	1	10	400
CDXLV777PLWE	Powerpoint vertical coverplate 2 gang white	NZ HBG	9321001394051	1	10	120
CDXLV777XPLMS	Powerpoint vertical coverplate 2 gang extra switch matt silver	NZ HBG	9321001394037	1	10	120
CDXLV777PLMS	Powerpoint vertical coverplate 2 gang matt silver	NZ HBG	9321001394020	1	10	120
CDXL777PLSS	Powerpoint coverplate 2 gang stainless steel	HBG	9321001261360	1	10	400
CDXL777PLPB	Powerpoint coverplate 2 gang polished brass	HBG	9321001134879	1	10	400
CDXL777XPLWE	Powerpoint coverplate 2 gang with extra switch white	HBG	9321001393382	1	10	400
CDXL777XPLMS	Powerpoint coverplate 2 gang with extra switch matt silver	HBG	9321001413073	1	10	400
XL777XPLPB	Powerpoint coverplate 2 gang with extra switch polished brass	CSO PB	9321001118527	1	10	-
XL777XPLSS	Powerpoint coverplate 2 gang with extra switch stainless steel	CSO PB	9321001158929	1	10	-

Excel mechanisms

Switch and dimmer mechanisms



XL770/1GPLWE



CD770MWE



D5MWE



DCS1

Cat.Nos		Pack	Barcode	Single qty	Inner qty	Outer qty
Powerpoints coverplates						
Grid & Plate						
XL770/1GPLWE	1 gang grid & coverplate	CS0 PB	9321001107125	1	10	160
XL770/2GPLWE	2 gang grid & coverplate	CS0 PB	9321001108733	1	10	160
Rocker switch mechanisms - Single Pole Double Throw (SPDT)						
CD770MWE	Switch mech. 1 & 2 way 10A 240V a.c. M80 motor rating white	BL	9321001271109	1	10	400
CD770MBL	Switch mech. 1 & 2 way 10A 240V a.c. M80 motor rating black	BL	9321001397052	1	10	400
Cordline switches						
D5MWE	Cordline switch for 3-core or figure-8 wiring double pole 10A white	BL	9310539727202	1	10	300
D5MBL	Cordline switch for 3-core or figure-8 wiring double pole 10A black	BL	9321001062158	1	10	300
Cupboard door switch						
DCS1	Cupboard door switch lever type	NZ BL	9415733001315	1	10	-
Dimmer mechanisms & fan controllers						
Dimmers						
CD400TMWE	Rotary dimmer trailing edge 2 wire 400VA 240V a.c. white	BX	9321001416333	1	20	120
Fan controllers						
CD300FMWE	Fan controller rotary 3 speed 300VA 240V a.c. white	BL	9321001416364	1	20	120
Knobs						
CDKNOB1WE	Dimmer & fan knob white	BL	9321001287490	1	10	240

Excel

USB, phone, TV, data and AV sockets



R770USB2PSMWE



CD770CXMWE



CD1210S2



D1209/2.5



D420/1WE

Cat.Nos		Pack	Barcode	Single qty	Inner qty	Outer qty
	Dual USB charger mechanism					
	For plasterboard or single brick installations					
R770USB2PSMWE	USB charger mech. 2 x 2.4A 250V a.c. white	HBG	9321001454304	1	5	80
R770USB2PSMBL	USB charger mech. 2 x 2.4A 250V a.c. black	HBG	9321001454311	1	5	80
	TV mechanisms					
CD770CXMWE	F connector saddle socket female to PAL for HPM 770 grids white	HBG	9310539017181	1	10	400
D770CXFP	Coaxial female plug top 75 Ohm white	HBG	9310539821603	1	10	400
D770CXP	Coaxial TV plug top 75 Ohm white	HBG	9310539831008	1	10	160
D770CXPSE	Coaxial TV plug top 75 Ohm side entry white	HBG	9310539831206	1	10	400
CD1210S2	TV splitter 2 way saddle	HBG	9321001134411	1	5	120
CD1210S4	TV splitter 4 way saddle	HBG	9321001134428	1	5	120
CD1310FS	TV mechanism F type to PAL	HBG	9321001397472	1	10	100
D1209/2.5	Antenna cable 2.5 metre	HBG	9310539828404	1	10	80
D1210/2	TV splitter adaptor 2 way	HBG	9321001134442	1	10	240
D1211	TV coaxial plug joiner	HBG	9310539830001	1	10	400
D1214/1	TV to video fly lead	HBG	9310539828800	1	10	200
	Phone mechanisms					
D420/14	Telephone double adaptor plug white	HBG	9321001178866	1	10	200
D420/15	Telephone adaptor skirting mount modular standard white	HBG	9321001178903	1	10	-
D420/16	Double extension lead single to double modular plug with 5m lead white	HBG	9321001178873	1	10	-
CD420/18	Extension telephone lead 1 mtr white	HBG	9321001183617	1	10	200
D420/19	In-line modular adaptor/ cable joiner for tel&data white	HBG	9321001186816	1	10	-
D420/1WE	Telephone double adaptor standard to standard white	HBG	9310539015576	1	10	400

Standard

Switches, dimmers



CD770/1WE



CD770/2WE



CD600WE



CD300FWE



CDA770/1WE

Cat.Nos	Vertical switches and dimmers	Pack	Barcode	Single qty	Inner qty	Outer qty
Rocker switches - Single Pole Double Throw (SPDT)						
CD770/1WE	Switch 1 gang 10A 240V a.c. white	HBG	9321001271062	1	10	200
CD770/2WE	Switch 2 gang 10A 240V a.c. white	HBG	9321001271079	1	10	200
CD770/3WE	Switch 3 gang 10A 240V a.c. white	HBG	9321001271086	1	10	200
CD770/4WE	Switch 4 gang 10A 240V a.c. white	HBG	9321001271093	1	10	200
Intermediate switch						
CDAL770/12WE	Switch intermediate 1 gang 10A 240V a.c. white	HBG	9321001271246	1	10	200
CDAL770/12HWSWE	Switch intermediate 1 gang 15A 240V a.c. "hws" white	NZ HBG	9321001416272	1	10	120
35A switches						
CDF1036/3WE	Switch 1 gang 35A with loop white	NZ HBG	9321001394013	1	10	120
Older style round switches						
CD65WE	Switch 1 gang 2 way 10A 240V a.c. old style round surface mount white	HBG	9321001271048	1	10	240
Cord-pull ceiling switches						
CD600WE	Ceiling switch cord-pull 1 gang 10A 240V a.c. rectangle white	HBG	9321001271031	1	5	120
CD601WE	Ceiling switch cord-pull 1 gang 10A 240V a.c. round white	HBG	9310539002804	1	5	100
Trailing edge rotary dimmers						
CD200LWE	Rotary dimmer trailing edge 250VA 240V a.c. white	HBG	9321001389453	1	5	100
Fan controllers						
CD300FWE	Fan controller 300VA white	HBG	9321001171409	1	5	120
Architrave						
CDA770/1WE	Architrave switch 1 gang 2 way 10A 240V a.c. white	HBG	9321001271215	1	10	240
CDA770/2WE	Architrave switch 2 gang 2 way 10A 240V a.c. white	HBG	9321001271222	1	10	240
CDA770/3WE	Architrave switch 3 gang 2 way 10A 240V a.c. white	HBG	9321001271239	1	10	240

N New product

++ More info available. See technical pages

COMING SOON Coming soon

X Product to be discontinued

NZ Product only available in New Zealand

CSO Customer Special Order

CS = Clam Shell, BL = Blister pack, BX = Box, SL = Sleeve, HSL = Hang sell sleeve, HBG = Hang sell bag, HBX = Hang sell box, TG = Tag. For more details on packaging see page 4.

Standard

Powerpoints, phone, TV, data and AV sockets and plates



CDV787WE

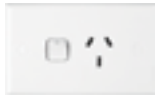

CD787WE



CD787XWE



CD790WE

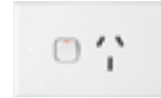

CD787/15WE



CD770/0WE

Cat.Nos		Pack	Barcode	Single qty	Inner qty	Outer qty
Vertical powerpoints						
Single powerpoints						
CDV787WE	Powerpoint 1 gang 10A 240V a.c. white	HBG	9321001271260	1	10	200
Double powerpoints						
CDV777WE	Powerpoint 2 gang 10A 240V a.c. white	HBG	9321001271253	1	10	120
Horizontal powerpoints						
Single powerpoints						
CD787WE	Powerpoint 1 gang 10A 240V a.c. white	HBG	9321001271154	1	10	100
CD787XWE	Powerpoint 1 gang 10A 240V a.c. extra switch white	HBG	9321001271161	1	10	200
CD790WE	Powerpoint 1 gang 10A 240V a.c. narrow plate white	HBG	9321001271178	1	10	200
CD787/15WE	Powerpoint 1 gang 15A 240V a.c. white	HBG	9321001271147	1	10	100
Double powerpoints						
CD777WE	Powerpoint 2 gang 10A 240V a.c. white	BL	9321001271123	1	10	120
CD777XWE	Powerpoint 2 gang 10A 240V a.c. with extra switch white	BL	9321001271130	1	10	120
CD777/15WE	Powerpoint 2 gang 15A 240V a.c. white	BL	9321001271116	1	10	130
TV outlets						
CD770/1CXWE	TV outlet coaxial 1 gang 75 ohm white	HBG	9310539823003	1	10	200
CD1A770CXWE	TV outlet coaxial 1 gang deep plate architrave white	HBG	9310539822402	1	10	240
CDA770/1CXWE	TV outlet coaxial 1 gang 75 ohm architrave white	HBG	9310539820002	1	10	240
Telephone outlet plates						
CD770TOPLWE	Coverplate telephone outlet	HBG	9321001378471	1	10	400
Switch plates						
Rectangle plates						
CD770/1PLWE	Coverplate 1 gang white	HBG	9310539970004	1	10	400
CD770/2PLWE	Coverplate 2 gang white	HBG	9310539970103	1	10	400
Architrave plates						
CDA770/2PLWE	Architrave plate 2 gang white	HBG	9310539017396	1	10	400
Blank plates						
CD770/0WE	Blank plate white	HBG	9321001271055	1	10	400
Flush caps						
CDFLUSHCAPS	Flush caps plastic white 100 pack	HBG	9321001207313	100	10	-

Como

Switches and powerpoints



CDCM910/1HWE



CDCM920/2HWE



CDCM787WE



CDCM777WE

Cat.Nos		Pack	Barcode	Single qty	Inner qty	Outer qty
	Horizontal switches					
	Rocker switches - Single Pole Double Throw					
CDCM910/1HWE	Switch large 1 gang 10A 240V a.c. white horizontal N	HBG	9321001480983	1	5	60
CDCM920/2HWE	Switch large 2 gang 10A 240V a.c. white horizontal N	HBG	9321001481010	1	5	60
	Horizontal powerpoint					
	Single powerpoint					
CDCM787WE	Powerpoint 1 gang 10A 240V a.c. with switch white N	HBG	9321001469841	1	5	60
	Vertical powerpoints					
	Double powerpoint					
CDCM777WE	Powerpoint 2 gang 10A 240V a.c. square plate white N	HBG	9321001469834	1	4	48

N New product

++ More info available. See technical pages

COMING SOON Coming soon

x Product to be discontinued

NZ Product only available in New Zealand

CSO Customer Special Order

CS = Clam Shell, BL = Blister pack, BX = Box, SL = Sleeve, HSL = Hang sell sleeve, HBG = Hang sell bag, HBX = Hang sell box, TG = Tag. For more details on packaging see page 4.

Aqua

Weatherproof switches and powerpoints



RWL770/1MG



RWLF770/2MG



RWL787/15MG



RWLC787MG



RWL787USBMG



RWL777MG

Cat.Nos	Switches	Pack	Barcode	Single qty	Inner qty	Outer qty	
Slider switches IP66							
RWL770/1MG	1 gang switch 16A IP66 surface mount	N	BX	9321001483908	1	-	5
RWL770/2MG	2 gang switch 16A IP66 surface mount	N	BX	9321001483915	1	-	5
RWLF770/1MG	1 gang switch 16A IP66 shallow mount	N	BX	9321001483922	1	-	5
RWLF770/2MG	2 gang switch 16A IP66 shallow mount	N	BX	9321001483939	1	-	5
Powerpoints							
Single powerpoints							
RWL787/15MG	Single powerpoint 15A IP53 surface mount	N	BX	9321001483960	1	-	10
RWLC787MG	Compact Single powerpoint 10A IP53 surface mount	N	BX	9321001483977	1	-	10
RWLF787MG	Single powerpoint 10A IP53 shallow mount	N	BX	9321001483984	1	-	10
RWL787USBMG	Single powerpoint 10A IP53 with USB Type C surface mount	COMING SOON	BX	9321001484004	1	-	5
RWL787MG	Single powerpoint 10A IP53 surface mount		BX	9321001484011	1	-	10
Double powerpoints							
RWLF777MG	Double powerpoint 10A IP53 shallow mount	N	BX	9321001483946	1	-	10
RWL777MG	Double powerpoint 10A IP53 surface mount	N	BX	9321001483953	1	-	10

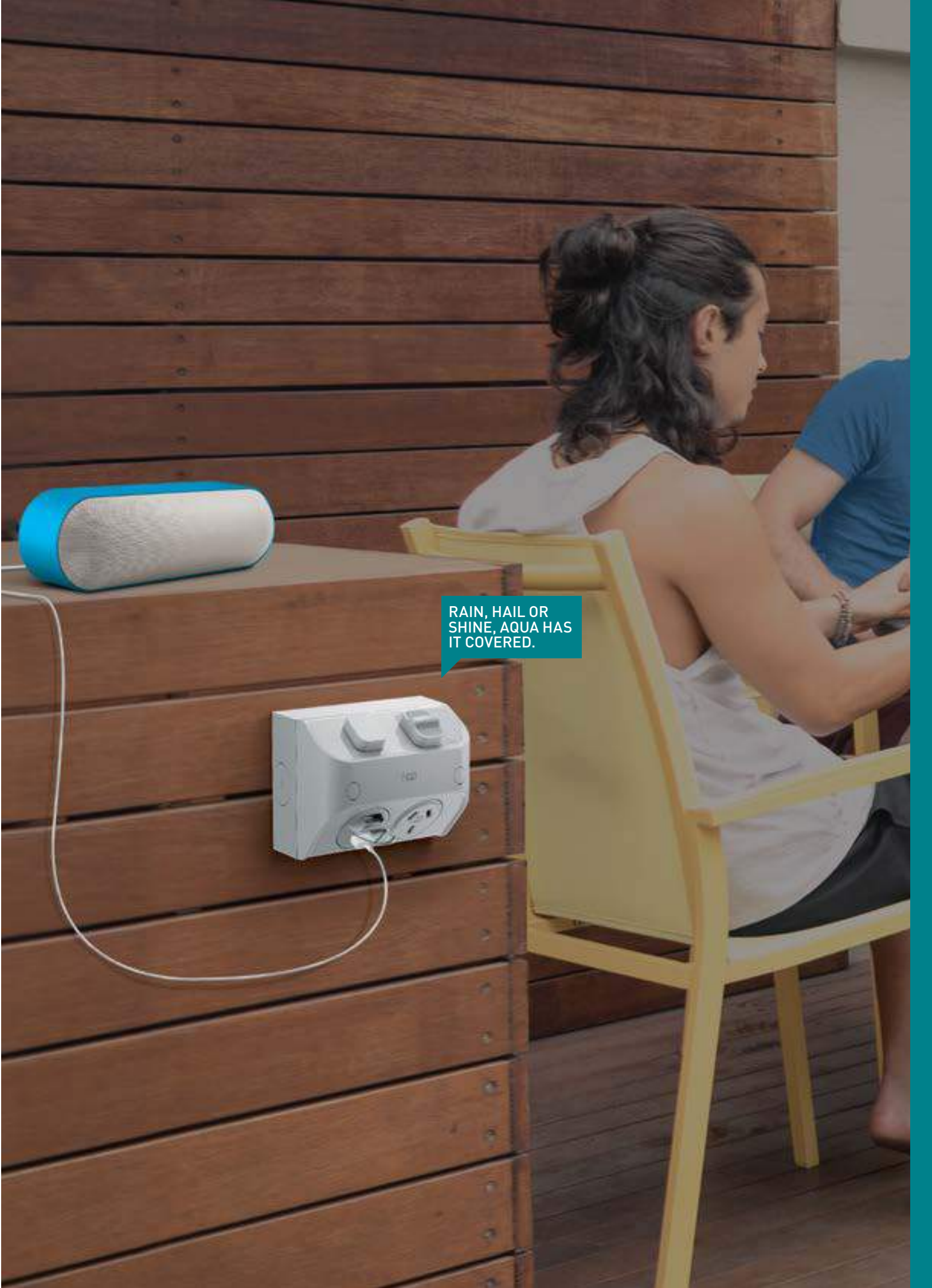

RAIN, HAIL OR SHINE, AQUA HAS IT COVERED.



GENERAL WIRING ACCESSORIES

Brackets



P. 71
Mounting brackets

Junction & wall boxes



P. 71
Wall boxes

Mounting blocks



P. 71
Deep mounting blocks

Other accessories



P. 72
Cable clips

Plug tops & base



P. 74
Plug tops

FEATURED PRODUCTS



Wall boxes
(p. 71)



Mounting blocks
(p. 71)



P. 71
Mounting clips



P. 72
Junction boxes



P. 71
13mm
mounting blocks

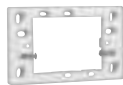

P. 71
Weatherproof
mounting blocks



P. 73
Insulated &
earth connectors



P. 74
Plug bases



P. 75
Safety plugs



P. 77
Plug-in MCB's



Cable clips
(p. 72)



Plug bases
(p. 74)



**Fast connector
plug bases**
(p. 74)

General wiring accessories solutions

INSTALLATION ACCESSORIES PRODUCTS THAT KEEP YOU PLUGGED-IN

The unsung heroes of electrical accessories. Unlike USB sockets, they fail to win media flattery. Unlike decorative lighting, they fail to woo social media likes. Alas, we guarantee they lurk everywhere, doing their thing, and keeping you comfortable in one way or another.



PLUG TOPS

We've been making plug tops for more than 60 years. Our first plug tops graced the ends of the Aussie Sunbeam mixmasters. We're always surprised where our products end up - they top all sorts of inventions, the humble and the grand.



PLUG BASES BEHIND EVERY GREAT LIGHT, THERE'S A PLUG BASE

When you're installing a gazillion luminaires, you need a plug base that's super easy to fit-off. That's where we come in. We work with electricians to ensure your everyday essentials are easy to install, and keep on working long after you've retired.



FAST CONNECTOR RELIABLE, SAFE AND FAST

HPM's fast-connect socket 37QC is fully compatible with the updated standard AS/NZS3112:2017: "Insulation piercing terminals or connecting devices shall conform to the relevant requirements of AS/NZS IEC 60998.2.3."



Accessories

Brackets, clip, wall boxes and mounting blocks



CD711



CD429



BU140WE

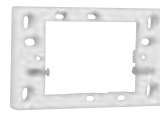

CD137WE



YF4

Cat.Nos		Pack	Barcode	Single qty	Inner qty	Outer qty
	Brackets					
	Mounting brackets					
R143	Mounting brackets	HBG	9310539520100	1	10	160
CD143	Mounting bracket metal	PB	9310539520100	1	10	160
CD143/2	Mounting bracket stud mount with nails metal	PB	9321001474883	1	10	120
	Clips					
	Mounting clips for plasterboard					
CD711	Mounting clips for 6.4mm plasterboard 50x76mm max cut-out	HBG	9310539521008	1	10	400
CD712	Mounting clips for 10mm plasterboard 50x76mm max cut-out	HBG	9321001281290	1	10	400
	Wall boxes					
	Standard wall boxes					
CD429	Wall box with sliding nuts, retent. clips & cover black	HBG	9321001271024	1	5	120
BU429R	Wall box with sliding nuts, retent. clips & cover black 10 pack	BX	9321001407386	10	-	-
	Mounting blocks					
	Deep surface mounting blocks					
CD140WE	Mounting block 37mm deep for switches & GPOs white	NZ BX	9321001270867	1	10	100
BU140WE	Mounting block 37mm deep for switches & GPOs white 10 pack	BX	9321001407331	10	-	-
	Surface mounting blocks for narrow plates					
CD150WE	Mounting block for narrow plates 78mm m. centres 52x150x24mm white	HBG	9310539502007	1	10	200
	Surface mounting blocks and spacers					
CD137WE	Mounting block for GPOs 84mm m. centres 13mm deep white	HBG	9321001270850	1	10	240
	Surface mounting blocks for 4 gang powerpoints and square plate					
137/1WE	Mounting block 16mm deep for 4 gang powerpoints white	HBG	9321001003489	1	5	135
	Surface mounting blocks - architrave size					
CD141WE	Mounting block for 1 gang architrave 57mm 74x28x25mm white	HBG	9321001270874	1	10	240
CD156WE	Mounting block for 2 gang architrave 70mm 86x36x26mm white	HBG	9310539502205	1	10	200
	Weatherproof mounting blocks for Aqua range					
C239WE	Mounting block for switches & GPOs weatherproof IP56 120x75x44mm white	HBG	9321001270799	1	8	80
	Universal flush box					
YF4	Flush box universal white, retained metal nuts	NZ HBG	9415733009595	1	100	100

N New product

+ More info available. See technical pages

COMING SOON Coming soon

X Product to be discontinued

NZ Product only available in New Zealand

CSO Customer Special Order

CS = Clam Shell, BL = Blister pack, BX = Box, SL = Sleeve, HSL = Hang sell sleeve, HBG = Hang sell bag, HBX = Hang sell box, TG = Tag. For more details on packaging see page 4.

Accessories

Junction boxes and cable clips



CD404 / BU404



CD413



CD406



DQ002



DQ003



DQ011

Cat.Nos		Pack	Barcode	Single qty	Inner qty	Outer qty
Junction boxes						
CD404	Junction box with 4 x 40A connectors (3x1+1x2 screws) 68x68x38mm white	BX	9321001270997	1	10	200
BU404	Junction box with 4 x 40A connectors (3x1+1x2 screws) 68x68x38mm white 10 pack	BX	9321001407324	10	-	-
CD405	Junction box without connectors 68x89x44mm white	BL	9321001474876	1	5	60
CD406	Junction box with 4 x 50A connectors (3x1+1x2 screws) 68x89x44mm white	BL	9321001271000	1	5	120
CD413	Junction box with 3 terminals 6mm 30A 37x68x22mm white	BL	9321001271017	1	10	240
Cable clips						
Round type						
DQ003	Cable clips round 6mm white 20 pack	BL	9321001415411	20	10	200
DQ004	Cable clips round 6mm black 20 pack	BL	9321001415428	20	10	200
DQ009	Cable clips round 10mm white 20 pack	BL	9321001415473	20	10	200
DQ109	Cable clips round 10mm white 100 pack	BL	9321001415541	100	5	50
Flat type						
CL3B	Cable clips flat 13mm with captive set nail 50 pack	BL	9321001244127	50	-	8
CL4B	Cable clips flat 15mm with captive set nail 50 pack	BL	9321001396185	50	-	8
DQ001	Cable clips flat 5mm white 20 pack	BL	9321001415398	20	10	200
DQ002	Cable clips flat 5mm black 20 pack	BL	9321001415404	20	10	200
DQ005	Cable clips flat 7mm white 20 pack	BL	9321001415435	20	10	200
DQ006	Cable clips flat 7mm black 20 pack	BL	9321001415442	20	10	200
DQ010	Cable clips flat 13mm white 20 pack	BL	9321001415480	20	10	200
DQ011	Cable clips flat 15mm white 20 pack	BL	9321001415497	20	10	200
DQ105	Cable clips flat 7mm white 100 pack	BL	9321001415510	100	5	50
DQ110	Cable clips flat 13mm white 100 pack	BL	9321001415558	100	5	50
DQ111	Cable clips flat 15mm white 100 pack	BL	9321001415565	100	5	50
DQ201	Cable clips flat 5mm white 200 pack	BL	9321001415503	200	5	50
RQ710B	Cable clips flat 7-10mm 100 pack	BL	9321001205807	100	-	60
Hook type						
DQ007	Cable clips hook 8-10mm white 20 pack	BL	9321001415459	20	10	200
DQ008	Cable clips hook 8-10mm black 20 pack	BL	9321001415466	20	10	200
DQ107	Cable clips hook 8-10mm white 100 pack	BL	9321001415527	100	5	50
DQ108	Cable clips hook 8-10mm black 100 pack	BL	9321001415534	100	5	50
DQU30	Cable pin clips	HSL	9310539907901	1	10	200

New product

More info available. See technical pages

Coming soon

Product to be discontinued

Product only available in New Zealand

Customer Special Order

CS = Clam Shell, BL = Blister pack, BX = Box, SL = Sleeve, HSL = Hang sell sleeve, HBG = Hang sell bag, HBX = Hang sell box, TG = Tag. For more details on packaging see page 4.

Accessories

Insulated and earth connectors



CD401



CD402



D35P6

Cat.Nos		Pack	Barcode	Single qty	Inner qty	Outer qty
Cable ties						
RQ16	Handy ties 140mm X 3.6mm black 20 pack	HBG	9310539003122	20	10	250
RQ17	Handy ties 203mm X 4.8mm black 20 pack	HBG	9310539003115	20	10	200
RQ18	Handy ties 280mm X 4.8mm black 20 pack	HBG	9310539002781	20	10	100
RQ16WE	Handy ties 140mm x 3.6mm white 20 pack	HBG	9415733001025	20	10	-
RQ17BL	Handy ties 203mm x 4.8mm black 20 pack	HBG	9415733001278	20	10	-
RQ17WE	Handy ties 203mm x 4.8mm white 20 pack	HBG	9415733001032	20	10	-
RQ18BL	Handy ties 280mm x 4.8mm black 20 pack	HBG	9415733001032	20	10	-
Screws						
CD246	Screws 76mm 6-32 thread nickel plated/florentine bronze	HBG	9321001270881	1	10	200
CD247	Screws 51mm 6-32 thread nickel plated/florentine bronze	HBG	9321001256960	1	12	240
Insulated and earth connectors						
CD401	Connector heavy duty 40A 1 screw 6mm hole clear 10 pack	HBG	9321001270973	10	10	240
BU401/1	Connector heavy duty 40A 1 screw 6mm hole clear 100 pack	BX	9321001407478	100	-	-
CD402	Connector heavy duty 40A 2 screws 6mm hole clear 10 pack	HBG	9321001270980	10	10	240
D35P6	Terminal block connector strip 6 way white	BL	9310539907604	1	10	240
R401B	Connector heavy duty 40A 1 screw 6mm hole clear 100 pack	HBG	9310539401409	100	50	750
R402B	Connector heavy duty 40A 2 screws 6mm hole clear 100 pack	HBG	9310539402901	100	50	750

Accessories

Plug tops and plug bases



CD100LWE



CD106/1WE



CD37CL



CD37QC

Cat.Nos	Plug tops	Pack	Barcode	Single qty	Inner qty	Outer qty
	10A plug tops					
CD100LWE	Plug top flexible PVC cover with cord locking nut 3 flat pins white	HBG	9321001275602	1	10	240
CD100LCL	Plug top flexible PVC cover with cord locking nut 3 flat pins clear	HBG	9321001275572	1	10	240
CD106/1WE	Plug top low profile side entry 3 flat pins white	HBG	9321001275916	1	10	240
106/1BL	Plug top low profile side entry 3 flat pins black	NZ HBG	9321001001799	1	10	200
CD106/2WE	Plug top slim side entry 3 flat pins white suits 15A hd flex. cord	HBG	9321001270829	1	10	240
CD100/8WE	Plug top 10A flat figure 8 white	HBG	9321001270805	1	10	240
CD100LBL	Plug top 10A black	HBG	9321001275589	1	10	240
CD100LGY	Plug top 10A grey	HBG	9321001275596	1	10	240
CD106/1GY	Plug top 10A low profile side entry grey	HBG	9321001275909	1	10	240
CD90/15WE	Plug top 15A with finger grips	NZ HBG	9310539200200	1	10	200
	15A plug tops					
CD100L15CL	Plug top 15A clear	HBG	9321001275619	1	10	240
CD100L15WE	Plug top 15A white	NZ HBG	9321001275633	1	10	240
CD100L15GY	Plug top 15A grey	HBG	9321001275626	1	10	240
CD106/3WE	Plug top low profile side entry 3 pin flat white	HBG	9321001270836	1	10	200
CD7P15WE	Socket plug extension 15A 3pin flat white	NZ HBG	9321001275992	1	10	200
CD90WE	Plug top 10A with finger grips	NZ HBG	9310539200002	1	10	200
YR1	Rubber plug top 10A black (male)	NZ HBG	9415255000346	1	25	125
	Plug bases					
	10A plug bases					
YR2	Rubber socket 10A black (female)	NZ HBG	9415255000353	1	25	125
CD37CL	Plug base single surface mount 3 flat pins 50mm m. centres clear	HBG	9321001370598	1	10	100
BU37CL	Plug base single surface mount 3 flat pins 50mm m. centres clear 10 pack	BX	9321001407355	10	-	-
CD37/2CL	Plug base double surface mount 3 flat pins 84mm m. centres clear	BX	9321001462057	1	10	100
CD37QC	Fast-connect plug base 3 flat pins 10A Ø65mm white	N HBG	9321001462057	1	10	100
BU37QC	Fast-connect plug base 3 flat pins 10A Ø65mm white 10 pack	N BX	9321001462033	10	-	10

Accessories

Plug tops and plug bases



CD1002



CD7PBL



CD7P15CL

Cat.Nos		Pack	Barcode	Single qty	Inner qty	Outer qty
	Child safety plugs					
CD1002	Safety plug 3 pins 6 pack	HBG	9310539204208	6	10	200
D1002/1	Safety plug slimline 3 pins 12 pack	HBG	9321001234883	12	10	200
	Cord extension socket					
	10A cord extension sockets					
CD7PBL	R-entry cord extension socket 10A black	HBG	9321001393993	1	10	200
CD7PCL	Cord extension socket 10A clear	HBG	9321001275978	1	10	200
CD7PGY	Cord extension socket 10A grey	HBG	9321001275961	1	10	200
CD7PWE	Cord extension socket 10A white	HBG	9321001275985	1	10	200
	15A cord extension sockets					
CD7P15CL	Socket plug extension 15A 3pin flat clear	HBG	9321001271185	1	10	200
CD7P15GY	Socket plug extension 15A 3pin flat grey	HBG	9321001271192	1	10	200
	IP44 plug and socket					
57434	Tempra IP44 straight plug 2P+E 16A 200-240Va.c.	NZ HBG	3245060574345	1	-	-
57514	Tempra IP44 mobile socket 2P+E 16A 200-240V a.c.	NZ HBG	3245060575144	1	-	-

N New product

++ More info available. See technical pages

COMING SOON Coming soon

X Product to be discontinued

NZ Product only available in New Zealand

CSO Customer Special Order

CS = Clam Shell, BL = Blister pack, BX = Box, SL = Sleeve, HSL = Hang sell sleeve, HBG = Hang sell bag, HBX = Hang sell box, TG = Tag. For more details on packaging see page 4.



TIME IS MONEY!
THE 37QC FAST CONNECT
SOCKET MAKES INSTALLS
QUICK AND EASY.



Plug-in Circuit Breaker

Plug-in Circuit Breakers and mini circuit breakers - over load and short circuit protection



CDCB108



CDCB116



CDCB120



CDCB132



DMCB16



DMCB10



DMCB32

Cat.Nos	Plug-in circuit breaker 240V a.c.	Pack	Barcode	Single qty	Inner qty	Outer qty
CDCB108	1 pole 8A suitable for lighting circuits - brown handle	HBG	9310539909004	1	5	60
CDCB116	1 pole 16A suitable for lighting circuits - blue handle	HBG	9310539909103	1	5	60
CDCB120	1 pole 20A suitable for lighting circuits - yellow handle	HBG	9310539909202	1	5	60
CDCB132	1 pole 32A suitable for lighting circuits - red handle	HBG	9310539909301	1	5	60
	Mini circuit breaker 240V a.c.					
DMCB6	1 pole 6A suitable for lighting circuits - white	HBG	9415733001216	1	5	40
DMCB10	1 pole 10A suitable for lighting circuits - grey	HBG	9415733001223	1	5	40
DMCB16	1 pole 16A suitable for lighting circuits - blue	HBG	9415733001230	1	5	40
DMCB20	1 pole 20A suitable for lighting circuits - yellow	HBG	9415733001247	1	5	40
DMCB32	1 pole 32A suitable for lighting circuits - red	HBG	9415733001254	1	5	40
DMCBBASE	Mini circuit breaker base suitable for all HPM mini circuit breakers	HBG	9415733010669	1	-	-

New product

More info available. See technical pages

Coming soon

Product to be discontinued

Product only available in New Zealand

Customer Special Order

CS = Clam Shell, BL = Blister pack, BX = Box, SL = Sleeve, HSL = Hang sell sleeve, HBG = Hang sell bag, HBX = Hang sell box, TG = Tag. For more details on packaging see page 4.



POWERBOARDS

Standard



P. 81
Overload protection
1.8m

**Master switch
and heavy duty**



P. 81
Master switch

**Individually
switched**



P. 81
Switched outlets

USB/TV



P. 81
USB Chargers

FEATURED PRODUCTS

USB powerboards
(p. 81)



**Worksite portable
powercentre**
(p. 82)



P. 81
Transformer
spacing



P. 81
Transformer
spacing black



P. 81
Surge
protection



P. 81
Master switch



P. 81
Master switch-RJ11



P. 82
Plug Boss
heavy duty



P. 82
Plug Boss
heavy duty RCD



P. 81
Switched outlets
black



P. 85
Switched
6 outlets



P. 86
Worksite portable
powercentre



P. 81
TV&AV



P. 81
TV&AV
8 outlets



P. 82
Power adaptor



Power adaptor
(p. 82)



**Plug Boss
heavy duty RCD**
(p. 82)

Powerboards solutions



GENERAL WE MAKE PRODUCTS TO KEEP YOU MULTI-TASKING

Powerboards are the ultimate multi-taskers. Behind every great building, fashion shoot, lead singer, surfboard shaper, and time-based video artist, we swear there is a powerboard. A basic powerboard for those who prefer outlets with switches to protect your computing and entertainment equipment or if you have lots of chunky transformers that demand extra space between outlets.

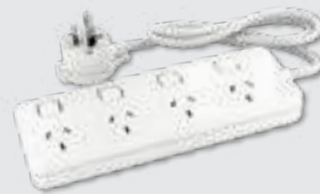

USB POWERBOARDS

Save space! Forget bulky adaptors, plug your USB cords straight into the two neat USB outlets on this powerboard. These are the new standard for general, everyday powerboards. Accept nothing less.



PLUG BOSS

Ideal for workshops and those who love heavy duty, industrial style design. This rugged, durable powerboard features a protective finish to withstand knocks and scrapes and a large hanging hook to give you more flexibility to position power where you need it. It also features a cord wrapping channel to help you keep the cord neat or a 'parking clip' to help prevent the lead unravelling when not in use.



POWERCENTRE

There are strict rules about what goes on a construction site, and our powercentres meet all of them. This unit features four 10A double pole powerpoints with safety shutters, along with the best quality lead and residual current protection. Keep safe, add it to your kit.



Mobile products

Powerboards



D105MS4WE



D104WE



D104PACC



D104PAUSBWE



D105PAUSBWE



D105TVAV8BL

Cat.Nos		Pack	Barcode	Single qty	Inner qty	Outer qty
Standard 10A 2400W						
R105	4 outlets white overload protection 0.9m lead	HBG	9321001185093	1	10	50
D105/1	4 outlets white overload protection 1.8m lead	BL	9310539268804	1	5	45
D105/4TR	4 outlets white overload protection 1.8m lead transf. space	BL	9321001273714	1	8	32
D105/4TRPA	4 outlets white overload protection 1.8m lead 175J surge transf. space	BL	9321001273745	1	8	32
D105/5TRPA	5 outlets white overload protection 1.8m lead 175J surge transf. space	BL	9321001202127	1	5	30
D105/5TRPACC	5 outlets charcoal overload protection 1.8m lead 350J surge transf. space	BL	9321001435143	1	5	30
R105/6	6 outlets white overload protection 0.9m lead	HBG	9321001185109	1	10	50
R105/6TWIN	6 outlets white overload protection 0.9m lead twin pack	HBG	9321001260851	2	10	40
D105PA6	6 outlets white overload protection 1.8m lead 175J surge	BL	9310539268705	1	5	30
D105PA6CC	6 outlets charcoal overload protection 1.8m lead 175J surge	BX	9321001280361	1	4	32
D105PA8	8 outlets white overload protection 1.8m lead 175J surge	BL	9321001391340	1	5	25
D105PA8CC	8 outlets charcoal overload protection 1.8m lead 175J surge	BL	9321001391401	1	5	25
Master switch 10A 2400W						
D105MS4WE	4 outlets white overload protection 3m lead 350J surge	BL	9321001437864	1	5	20
D105MS6WE	6 outlets white overload protection 3m lead 350J surge	BL	9321001437871	1	5	20
D105MS6RJWE	6 outlets white 2x RJ 11 socket protection overload protection 3m lead 525J surge	HBX	9321001437888	1	5	20
Individual switched outlets 10A 2400W						
D104WE	4 outlets white overload protection 0.9m lead	BL	9310539018522	1	3	18
D104PAWE	4 outlets white overload protection 1.8m lead 175J surge	BL	9310539018539	1	3	18
D104PACC	4 outlets charcoal overload protection 3m lead 525J surge	BL	9321001435112	1	3	18
D104PA6	6 outlets white overload protection 1.8m lead 175J surge	BL	9321001391289	1	5	20
USB chargers 10A 2400W						
D104PAUSBWE	4 outlets white overload protection 1.8m lead 525J surge 2x2.4A USB	HBX	9321001432425	1	4	24
D104PAUSBACWE	4 outlets white overload protection 1.8m lead 525J surge 2x USB 5A MAX	HBX	9321001481188	1	4	24
D105PAUSBWE	4 outlets white overload protection 1.5m lead 175J surge 2.1A total USB	HBX	9321001432395	1	6	36
D105PAUSBACWE	4 outlets white overload protection 1.5m lead 175J surge 2x USB 5A MAX	HBX	9321001485438	1	6	36
TV & AV 10A 2400W						
D105TVAV4BL	4 outlets black 2.0m lead overload protection 875J surge	HBX	9321001437833	1	5	20
D105TVAV6BL	6 outlets black 3.0m lead overload protection 2800J surge	HBX	9321001437840	1	4	16
D105TVAV8BL	8 outlets black 3.0m lead overload protection 3150J surge	HBX	9321001437857	1	4	12
D105/12TRPA	12 outlets white overload protection 1.8m lead 175J surge	BL	9321001391319	1	8	16
D105/12TRPPCC	12 outlets charcoal overload protection 1.8m lead 175J surge	BL	9321001391371	1	8	16

New product

Energy Saving products

More info available. See technical pages

Coming soon

Product to be discontinued

Product only available in New Zealand

CS = Clam Shell, BL = Blister pack, BX = Box, SL = Sleeve, HSL = Hang sell sleeve, HBG = Hang sell bag, HBX = Hang sell box, TG = Tag. For more details on packaging see page 4.

Mobile products

Powerboards and powercentre



D105SSPA4



D105POD4



D105PBOSSPA4



D105PBOSSPA8



REPC410USB



REPC11015

Cat.Nos		Pack	Barcode	Single qty	Inner qty	Outer qty
Child-safe 10A 2400W						
D105SSPA4	4 outlets white overload protection 0.9m lead 150J surge	BL	9321001260912	1	4	40
D105SSPA6	6 outlets white overload protection 1.8m lead 150J surge	BL	9321001260936	1	8	32
D105POD4	4 outlets white overload protection 0.9m lead 1050J surge	BL	9321001389361	1	3	18
D105POD6	6 outlets white overload protection 0.9m lead 1050J surge	BL	9321001389392	1	3	18
Plugboss heavy duty 10A 2400W						
D105PBOSSPA4	4 outlets yellow/black overload protection 3.0m lead 1050J surge	HBX	9321001393245	1	5	20
D105PBOSS5	5 outlets yellow/black overload protection 1.8m lead	TG	9321001222286	1	5	20
D105PBOSSPA6	6 outlets yellow/black overload protection 3.0m lead 700J surge	TG	9321001222293	1	4	12
D105PBOSSPA8	8 outlets yellow/black overload protection RCD protect 3.0m lead 700J surge	TG	9321001275510	1	4	12
Worksite portable powercentre						
10A 2400W						
REPC410	4 outlets IP33 orange RCBO protection 1.8m lead	BX	9321001370222	1	-	9
REPC410USB	4 outlets IP33 orange RCBO protection 1.8m lead 2 x 4.8A USB	BX	9321001431114	1	-	9
REPC410USBAC	4 outlets IP33 orange RCBO protection 1.8m lead 2 x USB A&C 5A max	BX	9321001485469	1	-	9
15A 3600W						
REPC415	4 outlets IP33 orange RCBO protection 1.8m lead	BX	9321001370246	1	-	9
Power adaptor						
REPC11015	15A to 10A IP33 charcoal RCBO protection 1.8m lead ideal for caravans	BX	9321001435013	1	-	9



OUR POWERBOARDS
ARE THE ULTIMATE
MULTITASKERS.



EXTENSION LEADS

Household duty



P. 87
Standard

Heavy duty



P. 87
Standard
yellow

Extra heavy duty



P. 88
Tradesman

Various



P. 88
Heavy duty with
in-line RCD

FEATURED PRODUCTS



Plug Boss
(p. 88)



Extra heavy duty
(p. 88)



P. 87
Piggyback
socket



P. 87
Entertainment



P. 87
Locking socket



P. 88
Plug boss
locking socket



P. 88
Garden
heavy duty



P. 88
Caravan



P. 88
Construction lead



P. 88
Camping



P. 89
Cord locks



P. 89
Carry straps



P. 89
Cable reels



**Caravan
(p. 88)**



**Heavy duty
with inline RCD
(p. 88)**

Extension leads solutions



HOUSEHOLD HOUSEHOLD DUTY EXTENSION LEADS WITH PIGGY-BACK PLUG

A clever, everyday extension lead for the home or office. It features a convenient piggy-back plug, so you can turn one power outlet into two by plugging in other devices on the back of the plug top.



HEAVY DUTY

If you love spending hours in your workshop making furniture, shaping surfboards, inventing gadgets or creating film sets, PlugBoss leads could become your favourites. They feature a handy clamping socket which locks the two ends of the lead together to prevent the frustration caused by leads coming apart.



EXTRA HEAVY DUTY

These are ideal when you need a little extra durability, but don't wish to lug around the super heavy construction grade leads. They feature a handy clamping socket, that locks the two ends of the lead together to prevent the frustration and downtime caused by leads coming apart.



CARAVAN

A carefree life on the road travelling our rugged, beautiful country requires the best quality gear. To keep yourself safe, and to ensure you're powered wherever you wander, pack these extension leads in your kit.



CABLE REELS

Whether in the studio, concert hall, building site or at home, our cable reels are the best. Thicker, UV stabilised insulation and 100% copper wiring is what separates our cable reels from the el-cheapos. They are tougher, safer, less likely to catch fire or crack under the midday sun.



Mobile products

Extension leads



Cat.Nos	Household duty 10A 2400W	Pack	Barcode	Single qty	Inner qty	Outer qty
Standard						
R2702	2m lead white 3 core 1.0mm ²	HBG	9321001093367	1	10	40
R2703	3m lead white 3 core 1.0mm ²	HBG	9321001093381	1	10	40
R2705	5m lead white 3 core 1.0mm ²	HBG	9321001093428	1	5	25
R2707	7m lead white 3 core 1.0mm ²	HBG	9321001093466	1	5	20
R2710	10m lead white 3 core 1.0mm ²	HBG	9321001093527	1	5	15
R2715	15m lead white 3 core 1.0mm ²	HBG	9321001093565	1	5	10
R2720	20m lead white 3 core 1.0mm ²	HBG	9321001093589	1	4	8
Piggyback socket						
R2601	1m lead white 3 core 1.0mm ²	HBG	9321001141013	1	10	40
R2602	2m lead white 3 core 1.0mm ²	HBG	9321001141037	1	10	40
R2604	4m lead white 3 core 1.0mm ²	HBG	9321001141044	1	5	20
R2606	6m lead white 3 core 1.0mm ²	HBG	9321001141051	1	5	20
R2610	10m lead white 3 core 1.0mm ²	HBG	9321001141068	1	5	15
Entertainment						
R2702EB	2m lead black 3 core 1.0mm ²	HBG	9321001392644	1	10	40
R2703EB	3m lead black 3 core 1.0mm ²	HBG	9321001392675	1	10	40
R2705EB	5m lead black 3 core 1.0mm ²	HBG	9321001392705	1	5	25
Heavy duty 10A 2400W						
Standard						
R2805	5m lead yellow 3 core 1.0mm ²	SL	9321001407676	1	-	5
R2810	10m lead yellow 3 core 1.0mm ²	SL	9321001141075	1	-	5
R2815	15m lead yellow 3 core 1.0mm ²	SL	9310539279305	1	-	5
R2820	20m lead yellow 3 core 1.0mm ²	SL	9321001141099	1	-	5
R2825	25m lead yellow 3 core 1.0mm ²	SL	9310539279206	1	-	5
Locking socket						
R2810L	10m lead yellow 3 core 1.0mm ²	SL	9321001277187	1	-	5
R2815L	15m lead yellow 3 core 1.0mm ²	SL	9321001280217	1	-	5
R2820L	20m lead yellow 3 core 1.0mm ²	SL	9321001277200	1	-	5
R2825L	25m lead yellow 3 core 1.0mm ²	SL	9321001277224	1	-	5

New product

Energy Saving products

More info available. See technical pages

Coming soon

Product to be discontinued

Product only available in New Zealand

CS = Clam Shell, BL = Blister pack, BX = Box, SL = Sleeve, HSL = Hang sell sleeve, HBG = Hang sell bag, HBX = Hang sell box, TG = Tag. For more details on packaging see page 4.

Mobile products

Extension leads



Cat.Nos		Pack	Barcode	Single qty	Inner qty	Outer qty
Heavy duty 10A 2400W						
Plugboss locking socket						
R2810PBL	10m lead yellow/black 3 core 1.0mm ²	SL	9321001218982	1	-	5
R2820PBL	20m lead yellow/black 3 core 1.0mm ²	SL	9321001218999	1	-	5
Garden heavy duty						
R2815GL	15m lead yellow/green 3 core 1.0mm ²	SL	9321001218951	1	-	5
R2825GL	25m lead yellow/green 3 core 1.0mm ²	SL	9321001218975	1	-	5
Extra heavy duty 15A 3600W						
Tradesman						
R2910TL	10m lead red/black 3 core 1.5mm ² with locking socket		9321001411017	1	-	5
R2920TL	20m lead red/black 3 core 1.5mm ² with locking socket	SL	9321001411024	1	-	3
R2930TL	30m lead red/black 3 core 1.5mm ² with locking socket	SL	9321001411031	1	-	3
R2920	20m lead orange 3 core 1.5mm ²	SL	9310539279404	1	-	5
R2930	30m lead orange 3 core 1.5mm ²	SL	9310539015453	1	-	3
R2935	35m lead orange 3 core 1.5mm ²	SL	9321001196167	1	-	3
Caravan						
R2908/15	8m lead orange 3 core 1.5mm ²	SL	9310539005966	1	-	5
R2920/15	20m lead orange 15A 3 core 1.5mm ²	SL	9310539279503	1	-	5
R2910/15CV	10m lead orange 3 core 1.5mm ²	SL	9321001407690	1	-	5
R2915/15CV	15m lead orange 3 core 1.5mm ²	SL	9321001407706	1	-	3
R2920/15CV	20m lead orange 3 core 1.5mm ²	SL	9321001408659	1	-	3
R2925/15CV	25m lead orange 3 core 1.5mm ²	SL	9321001407713	1	-	3
Construction lead						
R2910/15CL	10m lead clear plug & socket blue 3 core 1.5mm ² with locking socket	SL	9321001413219	1	-	5
R2920/15CL	20m lead clear plug & socket blue 3 core 1.5mm ² with locking socket	SL	9321001413226	1	-	3
Extra heavy duty 10A 3600W						
Camping						
R2810CLRCD	10m lead yellow with RCD switch	BX	9321001450573	1	3	6
Heavy duty lead 10A 2400W with inline RCD						
R5102/1	2m lead IP66 RCD protection yellow 3 core 1.5mm ²	HBG	9310539003610	1	5	25
D5101	10A portable safety switch plug, 30mA on a 1.6m heavy duty safety lead	HBG	9310539285801	1	3	18

Mobile products

Accessories and cable reels



CD107



D105CR25HDS

Cat.Nos	Accessories		Pack	Barcode	Single qty	Inner qty	Outer qty
CD107	Cord locks for 3 pin plugs and extension sockets yellow		TG	9321001424680	1	-	3
RHH01	Carry straps for leads and hoses up to 5kg orange		TG	9415733001759	1	3	-
CD555104	Mobile caravan plug socket IP44 16A		TG	9321001424697	1	-	3
CD555124	Straight caravan plug socket IP44 16A		TG	9321001424703	1	-	3
Cable reels 10A 2400W							
D105CR10ODS	10m standard lead 4 outlets black 3 core 1.0mm ²		TG	9321001424680	1	-	3
RCR2	Cable reel bare		TG	9415733001759	1	3	-
D105CR25HDS	25m heavy duty lead 4 outlets yellow 3 core 1.0mm ²		TG	9321001424697	1	-	3
D105CR20XDS	20m extra heavy duty lead 4 outlets orange 3 core 1.5mm ²		TG	9321001424703	1	-	3

New product

Energy Saving products

More info available. See technical pages

Coming soon

Product to be discontinued

Product only available in New Zealand

CS = Clam Shell, BL = Blister pack, BX = Box, SL = Sleeve, HSL = Hang sell sleeve, HBG = Hang sell bag, HBX = Hang sell box, TG = Tag. For more details on packaging see page 4.



USB CHARGERS, TIMERS & ADAPTORS

USB Chargers



P. 93
Single adaptor

Analogue timers



P. 93
Analogue

Digital timers



P. 94
7 Day

Adaptors



P. 94
Double adaptor

FEATURED PRODUCTS



USB Accessories
(p. 93)



Plug-in timers
(p. 93)



P. 93
Twin USB



P. 93
5 Port USB



P. 93
World travel pack



P. 93
4 port world travel



P. 93
Compact



P. 93
Twin pack



P. 93
Slimline



P. 93
Outdoor IP44



P. 94
7 Day slimline



P. 94
Right extend



P. 94
Right extend audible alert



P. 94
International travel adaptor for EUR & USA



P. 94
International travel adaptor for UK



USB charging station
(p. 93)



Adaptors
(p. 94)

USB chargers, timers & adaptors solutions

CHARGING SOLUTIONS CHARGE 5 DEVICES QUICKLY AND EASILY

Recharge up to 71% of your cell phone battery in 30mins with fast charging up to 80W of power. Ultra slim and curved design, compact and portable with multiple safety protection and compatible with Quick Charge 3.0 and Power Delivery 2.0 specifications.



WHY HPM USB?



2 x 1A or 2 x 2.4A sockets for faster charging



Charge 2 x smartphones or 2 x tablets or MP3/4 players simultaneously at the maximum charging speed



Perfect for keeping mobile devices charged while travelling

TYPE C ACCESSORIES ON THE GO

Switch between USB-C and USB-A devices with the universal cable. Charge and synchronise data at a fast data transfer rate. Designed to last, perfect weight and size to carry with you.



TIMERS WE MAKE PRODUCTS TO SAVE YOU TIME AND MONEY

Remembering to turn off devices can be a hassle. Save yourself time and brain space, try one of these simple, easy to use timers. They are ideal for magically turning on and off devices like Christmas lights, pool pumps, heaters, and coffee machines.



Mobile products

USB chargers and plug-in timers



D2USB



PS2USB



D4USB



D810SLIMDP



D818ODDP

Cat.Nos	USB chargers		Pack	Barcode	Single qty	Inner qty	Outer qty
D2USB	Single adaptor with USB charger 10A socket 2x2.4A USB		HBX	9321001427162	1	6	36
PS2USB	Twin USB charging station socket 2x2.4A USB		HBX	9321001427179	1	6	36
PS5USB	5 port USB charging station 7.2A total		BX	9321001441694	1	4	40
D2USB121	World travel pack AUS/UK/USA/EUR socket 2x2.4A USB		HBX	9321001431435	1	6	36
D4USB	4 port world travel pack AUS/UK/USA/EUR 2x2.4A & 2x1A		HBX	9321001441663	1	4	40
D123CTC31	USB cable type A to Micro USB/USB-C/Lightning 3 IN 1		BX	9321001481096	1	10	40
D1234HTC	USB HUB Type C to 1 type C port & 3 type A ports 60W		BX	9321001481119	1	10	40
D123ATC	USB Adaptor Type C to Type A "ON TO GO" technology		BX	9321001481072	1	10	200
D1235TC	5 ports USB slim charging station 1 type C & 4 type A 80W		BX	9321001482581	1	4	40
D1235WTC	5 ports USB wireless charging station 1 type C & 4 type A 60W		BX	9321001482611	1	4	40
D1233TC	3 ports USB wall charger 1 type C & 2 type A 45W		BX	9321001482550	1	4	40
PS2USBAC	Twin USB Charging Station 2 USB A&C 5A Total white		BX	TBC	1	6	36
D2USBAC	2 USB A&C ports charger adaptor 5A Total - White		BX	TBC	1	6	36
Analogue timers 10A 2400W							
D818	24h 15min increments		CS	9310539809809	1	4	32
D818DP	NSW 24h 15min increments double pole*		CS	9321001464853	1	4	32
D809/1	24h 15min increments with offset		HSL	9321001260653	1	6	36
D809/1DP	NSW 24h 15min increments with offset double pole*		SL	9321001464747	1	6	36
D810/2	24h compact 15min increments		CS	9321001245148	1	5	40
D810/2DP	NSW 24h compact 15min increments double pole*		CS	9321001464822	1	5	40
D819/2	24h easy set override switch 15min increments		CS	9321001273486	1	6	60
D809/1TWIN	24h twin pack 15min increments with offset		CS	9321001260714	2	12	72
D809/1TWINDP	NSW 24h twin pack 15min increments with offset double pole*		CS	9321001464778	2	12	72
D809/1VP2DP	NSW 24h twin pack 15min increments with offset double pole*		CS	9321001464808	2	12	72
D810SLIM	24h slimline 30min increments		CS	9321001285267	1	6	36
D810SLIMDP	NSW 24h slimline 30min increments double pole*		CS	9321001455721	1	6	36
D810SLIMTP	24h slimline twin pack 30min increments		CS	9321001287681	2	12	72
D810SLIMTPDP	NSW 24h slimline twin pack 30min increments double pole*		CS	9321001455738	2	12	72
Analogue outdoor timers 10A 2400W							
D819/2DP	NSW 24h easy set override switch 15min increments double pole*		CS	9321001464884	1	6	60
D818ODDP	24h 30min increments analogue IP44 heavy duty M40 motor rating double pole*		CS	9321001457237	1	4	32

*Note

NSW Customers: Due to recent regulation changes, timers sold in NSW must be double pole (Cat. Nos ending with DP). Single pole timers will not be sold to NSW customers.



New product



Energy Saving products



More info available. See technical pages



Coming soon



Product to be discontinued



Product only available in New Zealand

CS = Clam Shell, BL = Blister pack, BX = Box, SL = Sleeve, HSL = Hang sell sleeve, HBG = Hang sell bag, HBX = Hang sell box, TG = Tag. For more details on packaging see page 4.

Mobile products

Plug-in timers, adaptors and others



D817SLIMDP



D102WE



D2/2WE



D2PAB



D121



R1202

Cat.Nos		Pack	Barcode	Single qty	Inner qty	Outer qty
Digital timers 10A 2400W						
D817/2	7 day 1min increments up to 14 ON/OFF settings per day battery back up	CS	9321001245131	1	5	40
D817/2DP	NSW 7 day 1min increments up to 14 ON/OFF settings per day battery back up double pole*	CS	9321001455714	1	5	40
D817SLIM	7 day slimline 1min increments up to 16 ON/OFF settings per day battery back up	CS	9321001391142	1	6	36
D817SLIMDP	NSW 7 day slimline 1min increments up to 16 ON/OFF settings per day battery back up double pole*	CS	9321001455745	1	6	36
D817SLIMTP	7 day slim. twin pack 1min increments up to 16 ON/OFF settings per day battery back up	CS	9321001426226	1	6	36
D817SLIMTPDP	NSW 7 day slim. twin pack 1min increments up to 16 ON/OFF settings per day battery back up double pole*	CS	9321001455752	1	6	36
Double adaptors 10A 2400W						
D102WE	Vertical white	BL	9310539221502	1	10	240
R102WE	Vertical white with display tag	TG	9321001243618	1	10	120
D2WE	Right extend white	BL	9310539224008	1	5	120
D2LWE	Left extend white	BL	9310539224206	1	5	120
D2/2WE	Right & left extend white twin pack	CS	9310539224404	2	10	200
D2PA	Right extend white 175J surge	BL	9310539224701	1	5	100
D2PAB	Right extend white audible alert 175J surge	BL	9321001155485	1	5	100
D2PA/2WE	Right & left extend white 175J surge twin pack	CS	9321001437635	2	10	200
International travel adaptors 10A 2400W						
D121	Complete set EUR/USA/UK white	CS	9310539205007	1	5	50
D122	For EUR/USA travellers to AUS/NZ white	CS	9310539206103	1	10	200
D121E	For AUS/NZ travellers to EUR white	CS	9310539205809	1	5	120
D121UK	For AUS/NZ travellers to UK white	CS	9310539205700	1	5	120
D121A	For AUS/NZ travellers to USA white	CS	9310539205908	1	5	120
Fuse wire						
R1202	Fuse wire 8A /16A twin pack fuse wires	HSL	9310539906003	2	20	200

*Note

NSW Customers: Due to recent regulation changes, timers sold in NSW must be double pole (Cat. Nos ending with DP). Single pole timers will not be sold to NSW customers.



New product



Energy Saving products



More info available. See technical pages



Coming soon



Product to be discontinued



Product only available in New Zealand

CS = Clam Shell, BL = Blister pack, BX = Box, SL = Sleeve, HSL = Hang sell sleeve, HBG = Hang sell bag, HBX = Hang sell box, TG = Tag. For more details on packaging see page 4.

CREATE A USB CHARGING HUB IN YOUR HOME WITH A SINGLE POWER SOCKET.

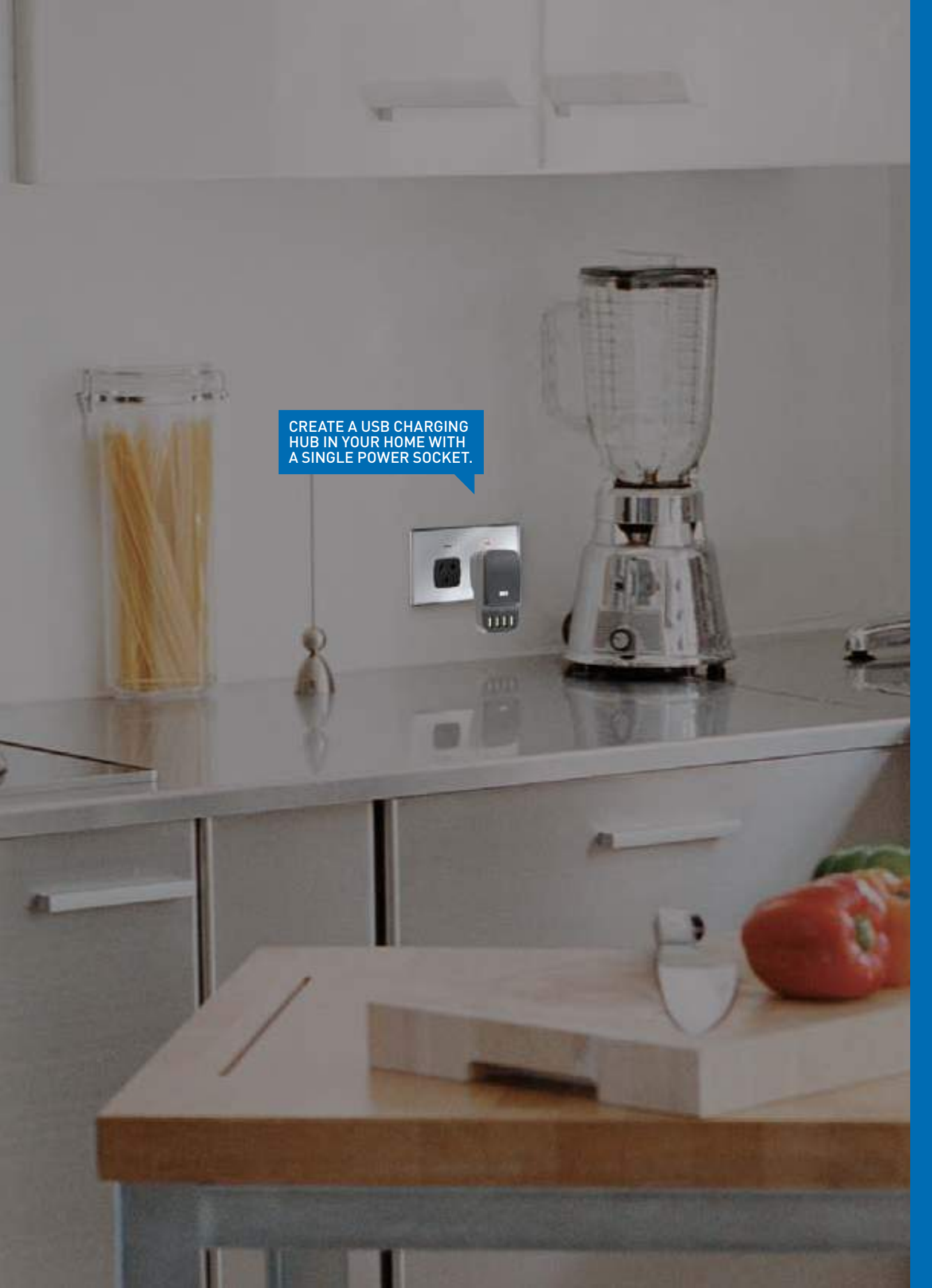



DOOR CHIMES

Battery operated



P. 99
100m range LED

Plug-in



P. 99
Piggy back adjustable volume

Bell press



P. 99
Single bell

Connected



P. 99
Single bell

FEATURED PRODUCTS



Battery operated
(p. 99)



Wireless door chimes
(p. 99)



P. 99
70m range



P. 99
70m range



P. 99
50m range
LED indicator



P. 99
30m range



P. 99
Piggy back



P. 99
35m range
piggy back



P. 99
Kit connected



**100m range
with LED indicator
(p. 99)**



**Connected
doorbell
(p. 99)**

Door chimes solutions

BATTERY OPERATED WE MAKE PRODUCTS FOR D.I.Y.

A simple, battery operated door chime. With no wiring, you can place them wherever you wish, or carry them with you so you never miss a delivery, or a visiting friend. Featuring a flashing light function, they are useful in circumstances when you cannot hear the door chime tune.



PLUG-IN A PRACTICAL, D.I.Y. DOOR CHIME

Featuring a piggy-back socket, you can use it as an additional socket for vacuum cleaners, lamps - anything you need. It also features a flashing light function, which comes in handy for circumstances when you cannot hear the door chime tune.



CONNECTED DOORBELL

If your bell press has been damaged, graffitied or has disappeared into thin air, we've got you covered. This bell press is suitable for use with any of the door chimes in our D641 series.



Mobile products

Door chimes



D642ELIOTBL



D642/L1



D641/BLRCC



D642/05



D641/PIFL

Cat.Nos			Pack	Barcode	Single qty	Inner qty	Outer qty
Wireless battery-operated							
D642/L1	White 100m range 433MHz 80dB 36 mel. with LED indicator	✕	CS	9321001424567	1	8	48
D642/L2	White 100m range 433MHz 80dB 36 mel.	✕	CS	9321001424574	1	8	48
D641/BLR	White 70m range 433.92MHz 12V d.c. 100dB 2 mel.		CS	9321001203353	1	5	20
D641/BLRCC	Charcoal 70m range 433.92MHz B29100dB 2 mel.		CS	9321001257127	1	5	20
D641/BFL	White 70m range 433.92MHz 80dB	✕	CS	9321001229674	1	5	50
D642/05	White round 50m range 433.05-434.79MHz 80dB 32 mel. with LED indicator	✕	CS	9321001259299	1	4	48
D642/01	White square 50m range 433.05-434.79MHz 80dB 32 mel. with LED indicator	✕	CS	9321001259053	1	4	48
D642/012R	White 50m range 433.05-434.79MHz 80dB 32 mel. x2 door chime receivers with LED indicator		CS	9321001434757	1	4	48
D641/B	White 30m range 433.92MHz 100dB 2 mel.	✕	CS	9321001218388	1	8	80
Wireless plug-in							
D641/PIFL	White 70m range 433.92MHz 70dB 2 mel. piggyback socket adjust. volume		CS	9321001227267	1	5	50
D641/PILR	White 70m range 433.92MHz 70dB 2 mel. piggyback socket		CS	9321001227250	1	5	50
D641/PI	White 35m range 433.92MHz 70dB 2 mel.		CS	9321001227243	1	5	50
Wireless bell presses							
D641/BPWE	White single bell press 433.92MHz for D641/PI series		CS	9321001227274	1	10	100
D641/BPCC	Charcoal single bell press 433.92MHz for D641/PI series	✕	CS	9321001257134	1	10	100
Eliot Connected Doorbell							
D642ELIOTWE	Connected doorbell White	N	BX	9321001482178	1	5	40
D642ELIOTBL	Connected doorbell Black	N	BX	9321001482208	1	5	40
D642ELIOTKIT	Kit connected doorbell push button + receiver white	N	BX	9321001482239	1	5	20



VENTILATION

Exhaust fans



P. 103
Wall exhaust fans

Bathroom heaters



P. 105
Single lamp
instant heat

Ceiling sweep fans



P. 106
White
aluminium finish

FEATURED PRODUCTS



Wall exhaust fans
(p. 103)



Ceiling exhaust fans
(p. 103)



P. 103
Non-ducted
ceiling exhaust fans



P. 103
Ducted ceiling
exhaust fans



P. 104
Accessories



P. 105
3-in-1
non-ducted units



P. 105
3-in-1
ducted units



P. 105
Replacement
heat lamps
and centre light



P. 106
Stainless
steel finish



P. 106
Rattan
white finish



P. 107
Accessories



**Non-ducted
instant heat
(p. 105)**



**Ceiling sweep fans
(p. 100)**



Ventilation solutions

SWEEP FANS STAY COOL

Something about ceiling fans evokes the sexiness of sultry summer nights in tropical destinations. By whisking away moisture from your skin, they provide sigh-worthy relief from the feeling of being strangled by humidity. We've designed our fans to be reliable, discreet wonders.



EXHAUST FANS KEEPING ROOMS FRESH

We all hate mould. For healthy air, great ventilation is essential. It helps prevent deadly mould from sprawling an evil path across your walls and ceilings. Whisk away bad odours and minimise condensation with these classic exhaust fans.



INSTANT HEAT KEEPING BATHROOMS HEALTHY AND WARM

Relish the toasty comfort of heat lamps. We vote these should be mandatory in all bathrooms prone to winter chills. Including heat lamps, exhaust fan & lights. These stylish units can create the perfect environment for your whims, whatever the reason or season.



Ventilation

Exhaust fans



EF100SQWE



EF100SQSWE



EF200RDWE



EF200SQWE



EFD01RDMS



R620LED

Cat.Nos		Pack	Barcode	Single qty	Inner qty	Outer qty
Wall exhaust fans						
100mm						
EF100SQWE	14W square white finish 94m ³ /h 158x158mm fascia	BX	9321001436157	1	-	4
EF100SQSWE	14W square slimline white finish 105m ³ /h 158x158mm fascia	BX	9321001436164	1	-	4
EF100RDWE	14W round white finish 105m ³ /h Ø190mm fascia	BX	9321001436171	1	-	4
150mm						
EF150SQWE	24W square white finish 218m ³ /h 212x212mm fascia	BX	9321001436188	1	-	4
EF150SQSWE	24W sq. slim white finish 309m ³ /h 212x212mm fascia	BX	9321001436195	1	-	4
EF150RDWE	24W round white finish 309m ³ /h Ø253mm fascia	BX	9321001436201	1	-	4
EFS150SQWE	24W sq. white finish w shutters 200m ³ /h 212x212mm fascia	BX	9321001436218	1	-	4
EFS150SQSWE	24W sq. slim white finish w shutters 267m ³ /h 212x212mm fascia	BX	9321001436225	1	-	4
Ceiling exhaust fans						
200mm non-ducted						
EF200RDWE	35W round white finish 350m ³ /h Ø287mm fascia	BX	9321001436256	1	-	4
EF200RDMS	35W round matt silver finish 350m ³ /h Ø287mm fascia	BX	9321001436263	1	-	4
EF200SQWE	35W square white finish 350m ³ /h 275x275mm fascia	BX	9321001436249	1	-	4
250mm non-ducted						
EF250RDWE	38W round white finish 400m ³ /h Ø372mm fascia	BX	9321001436287	1	-	4
EF250RDMS	38W round matt silver finish 400m ³ /h Ø372mm fascia	BX	9321001436294	1	-	4
EF250SQWE	38W square white finish 400m ³ /h 350x350mm fascia	BX	9321001436270	1	-	4
Ducted						
R621D1	34W square white finish 160m ³ /h 290x290mm fascia	BX	9321001256250	1	-	2
EFD01RDWE	40W round white finish 330m ³ /h Ø372mm fascia	BX	9321001455462	1	-	-
EFD01RDMS	40W round matt silver finish 330m ³ /h Ø372mm fascia	BX	9321001455967	1	-	-
EFD01SQWE	40W round square white finish 350m ³ /h Ø350mm fascia	BX	9321001455455	1	-	-
Inline exhaust fans						
EFIL100SQWE	30W 100mm square white finish 255m ³ /h	BX	9321001448877	1	-	2
EFIL150SQWE	60W 150mm square white finish 555m ³ /h	BX	9321001448884	1	-	-
Fanlights non-ducted						
R620LED	49W LED 200mm round white finish 300m ³ /h Ø340mm fascia	BX	9321001433989	1	-	2
R620	38W 200mm round white finish 300m ³ /h Ø340mm fascia	BX	9310539617206	1	-	2

Ventilation

Exhaust fans



R621/6D



R621/6WA



A100



A800



EFGR200RDWE



EFGR250RDWE

Cat.Nos	Accessories	Pack	Barcode	Single qty	Inner qty	Outer qty
	Wall kits					
R621/4D	100mm external grille, duct, cable ties, wall plugs for 100mm wall fans	BX	9321001141723	1	-	10
R621/6D	150mm external grille, duct, cable ties, wall plugs for 150mm wall fans	BX	9321001141792	1	-	10
	Time delay module					
EF100/150TD	1-29min for EF100 & 150 series wall fans	BX	9321001436232	1	5	60
	Duct adaptor					
R621D2DA	100 to 150mm duct adaptor	PL	9321001391524	1	-	-
	Ducting					
A100	Ø100mm x 3m length	BX	9321001189473	1	-	-
A101	Ø150mm x 3m length	BX	9321001189459	1	-	-
	External grilles					
A505	Ø150mm circular ceiling/wall diffuser	PL	9321001189305	1	-	-
A800	Ø100mm airflow shutter w gravity flaps	BX	9321001185727	1	-	20
	Replacement grilles for HPM ceiling exhaust fans EF series					
EFGR200RDWE	Ø200mm round white finish. Compatible with EF200 series	PL	9321001451907	1	5	40
EFGR250RDWE	Ø250mm round white finish. Compatible with EF250 series	PL	9321001451914	1	5	40

Ventilation

Bathroom heaters



BH1MS



BH2NDWE



BH4NDMS



BH2DWE



BH4DWE



LR80014K

Cat.Nos		Pack	Barcode	Single qty	Inner qty	Outer qty
Single heat lamp units						
BH1WE	275W square white with flex and plug Ø175mm cut-out	BX	9321001432456	1	-	12
BH1MS	275W square matt silver with flex and plug Ø175mm cut-out	BX	9321001432463	1	-	12
R615	275W round white hard-wired Ø170mm fascia	BX	9310539015880	1	-	10
3-in-1 non-ducted units						
BH2NDWE	2 lamps 690W 240m ³ /h Ø300mm cut-out white LED centre light	BX	9321001432470	1	-	-
BH2NDMS	2 lamps 690W 240m ³ /h Ø300mm cut-out matt silver LED centre light	BX	9321001432487	1	-	-
BH4NDWE	4 lamps 1240W 390m ³ /h 322x322mm cut-out white LED centre light	BX	9321001432494	1	-	-
BH4NDMS	4 lamps 1240W 390m ³ /h 322x322mm cut-out matt silver LED centre light	BX	9321001432500	1	-	-
R622/1AC	2 lamps 690W 240m ³ /h Ø300mm cut-out white	BX	9321001280330	1	-	-
R622/2AC	4 lamps 1240W 390m ³ /h 322x322mm cut-out white	BX	9321001280354	1	-	-
3-in-1 ducted units						
BH2DWE	2 lamps 840W 180m ³ /h 205x395mm cut-out white LED centre light	BX	9321001432517	1	-	-
BH4DWE	4 lamps 1570W 180m ³ /h 295x355mm cut-out white LED centre light	BX	9321001432531	1	-	-
R622D1	2 lamps 630W 130m ³ /h 335x180mm cut-out white instant heat ducted	NZ BX	9321001243779	1	-	2
R622D2	4 lamps 1240W 240m ³ /h 310x310mm cut-out white	BX	9321001243786	1	-	2
Replacement heat lamps						
L275HLES	275W single pack	BX	9321001160571	1	-	20
L375HLES	375W single pack	BX	9321001160588	1	-	20
MQ275	275W twin pack	BX	9318416018511	2	-	40
MQ275DP	275W twin pack	BX	9318416075149	2	-	48
Replacement LED centre light						
LR80014K	R80 LED lamp cool white 4000K 600 lm	BX	9321001434474	1	12	108

Ventilation

Ceiling sweep fans



CF9JWE



CF12HWE



CF14H4WE



CF12HBS



CF12T316L



CF13HAW

Cat.Nos	White aluminium		Pack	Barcode	Single qty	Inner qty	Outer qty
	3 blades						
CF9HWE	900mm hang-sure 4920m ³ /h 360rpm 55W		BX	9321001426523	1	-	-
CF9JWE	900mm J-hook 4920m ³ /h 360rpm 55W		BX	9321001426516	1	-	-
CF12HWE	1200mm hang-sure 10020m ³ /h 320rpm 65W		BX	9321001426561	1	-	-
CF12JWE	1200mm J-hook 10020m ³ /h 320rpm 65W		BX	9321001426554	1	-	-
CF14HWE	1400mm hang-sure 11040m ³ /h 280rpm 65W		BX	9321001426608	1	-	-
CF14JWE	1400mm J-hook 11040m ³ /h 280rpm 65W		BX	9321001426592	1	-	-
	4 blades						
CF12H4WE	1200mm hang-sure 10800m ³ /h 290rpm 65W		BX	9321001431503	1	-	-
CF12J4WE	1200mm J-hook 10800m ³ /h 290rpm 65W		BX	9321001431497	1	-	-
CF14H4WE	1400mm hang-sure 11880m ³ /h 255rpm 65W		BX	9321001431527	1	-	-
CF14J4WE	1400mm J-hook 11880m ³ /h 255rpm 65W		BX	9321001431510	1	-	-
	430 stainless steel 3 blades						
CF9HBS	900mm hang-sure 4920m ³ /h 360rpm 55W		BX	9321001426547	1	-	-
CF9JBS	900mm J-hook 4920m ³ /h 360rpm 55W		BX	9321001426530	1	-	-
CF12HBS	1200mm hang-sure 10020m ³ /h 320rpm 65W		BX	9321001426585	1	-	-
CF12JBS	1200mm J-hook 10020m ³ /h 320rpm 65W		BX	9321001426578	1	-	-
CF14HBS	1400mm hang-sure 11040m ³ /h 280rpm 65W		BX	9321001426622	1	-	-
CF14JBS	1400mm J-hook 11040m ³ /h 280rpm 65W		BX	9321001426615	1	-	-
	304 stainless steel 3 blades						
CF12J304	1200mm J-hook 10020m ³ /h 320rpm 65W		BX	9321001426639	1	-	-
CF14J304	1400mm J-hook 1104m ³ /h 280rpm 65W		BX	9321001426677	1	-	-
	316L marine grade stainless steel 3 blades						
CF12J316L	1200mm J-hook 10020m ³ /h 320rpm 65W		BX	9321001426653	1	-	-
CF14J316L	1400mm J-hook 11040m ³ /h 280rpm 65W		BX	9321001426691	1	-	-
	Rattan white 4 blades						
CF13HAW	1300mm hang-sure 7800m ³ /h 200rpm 65W		BX	9321001431480	1	-	-

Ventilation

Ceiling sweep fan accessories



CFCLWE



CFOLBS



CFOLLEDWE



CFOLLEDBS



CFREMOTEH

Cat.Nos	Ceiling sweep fan accessories	Pack	Barcode	Single qty	Inner qty	Outer qty
Replacement blades						
CFBL9WE	Single blades 900mm aluminium white	BX	9321001426837	1	-	20
CFBL12WE	Single blades 1200mm aluminium white	BX	9321001426851	1	-	20
CFBL14WE	Single blades 1400mm aluminium white	BX	9321001426875	1	-	20
CFBL9BS	Single blades 900mm stainless steel 430	BX	9321001426844	1	-	20
CFBL12BS	Single blades 1200mm stainless steel 430	BX	9321001426868	1	-	20
CFBL14BS	Single blades 1400mm stainless steel 430	BX	9321001426882	1	-	20
CFBL12316L	Single blades 1200mm stainless steel 316L	BX	9321001426912	1	-	20
CFBL14316L	Single blades 1400mm stainless steel 316L	BX	9321001426929	1	-	20
Extension downrods						
CFDR750HWE	750mm downrod aluminium hang-sure white	BX	9321001426769	1	-	10
CFDR750JWE	750mm downrod aluminium J-hook white	BX	9321001426752	1	-	10
CFDR750HBS	750mm downrod hang-sure stainless steel	BX	9321001426783	1	-	10
CFDR750JBS	750mm downrod J-hook stainless steel	BX	9321001426776	1	-	10
CFDR1500HWE	1500mm downrod aluminium hang-sure white	BX	9321001426806	1	-	10
CFDR1500JWE	1500mm downrod aluminium J-hook white	BX	9321001426790	1	-	10
Light kits						
CFCLWE	Clipper light kit Ø190mm aluminium white	BX	9321001426738	1	-	12
CFCLBS	Clipper light kit Ø190mm brushed stainless steel	BX	9321001426745	1	-	12
CFOLWE	Oyster light kit Ø245mm aluminium white	BX	9321001426714	1	-	12
CFOLBS	Oyster light kit Ø245mm brushed stainless steel	BX	9321001426721	1	-	12
CFOLLEDWE	Oyster light kit 8.5W 630 lm Ø190mm aluminium white dimmable	BX	9321001457329	1	-	12
CFOLLEDBS	Oyster light kit 8.5W 630 lm Ø190mm 304 stainless steel dimmable	BX	9321001457336	1	-	12
Remote control kit						
CFREMOTEH	Remote control hang-sure white	BX	9321001431152	1	-	20
CFREMOTEJ	Remote control J-hook white	BX	9321001431145	1	-	20

Technical information

Data and specifications

DOWNLIGHTS (LIGHTING)

How to choose a downlight in 6 steps



SWITCHES & SOCKETS

Product dimensions, wiring diagrams, mounting centres and dimmer characteristics



EXHAUST FANS

Installation guidelines, compatibility and wiring diagrams



How to choose a downlight

STEP 1

Are you replacing an existing downlight or is this a new installation?

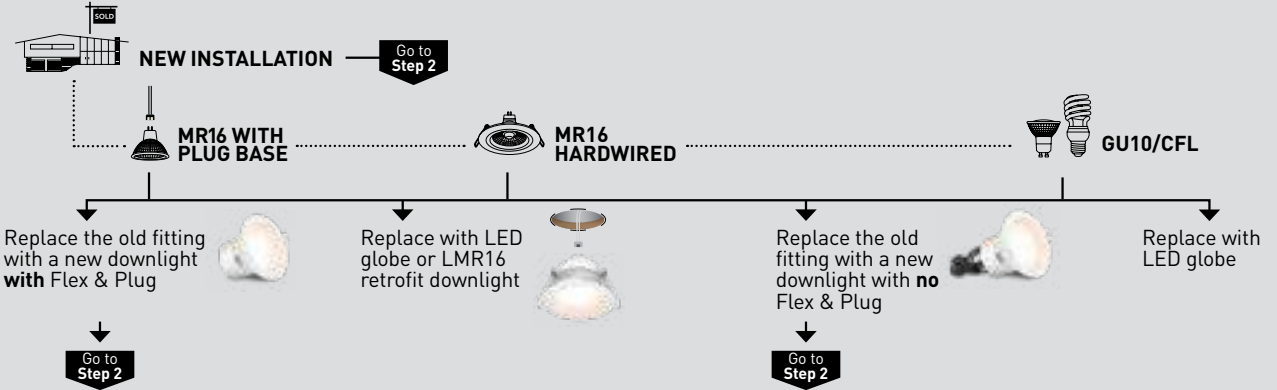

STEP 2

What size ceiling hole are you replacing or want to install?



LIGHT OUTPUT TABLE

	GU10 Globe	MR16 Globe	70mm LED Downlight	MR16 Globe	Retrofit LED Downlight	90mm LED downlight
Wattage	50W	35W	5-7W	50W	7-9W	7-12W
Lumens	300 lm	400 lm	500-600 lm	600 lm	600-800 lm	750-900 lm

STEP 3

Do you want your downlight to be dimmable or non-dimmable?

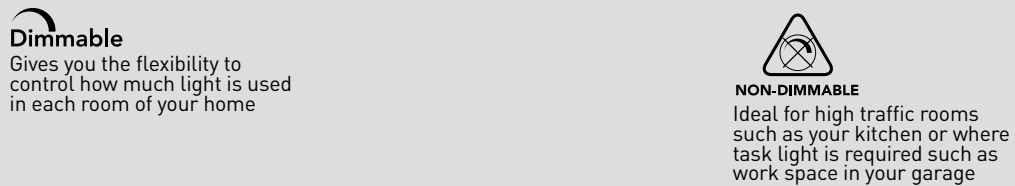

STEP 4

Do you require the downlight to have Surge Protection?

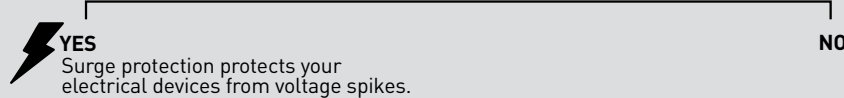

STEP 5

What colour do you want the downlight to be?

WARM WHITE 3,000K
Creates an inviting and relaxing mood making it the perfect choice for living areas and bedrooms

COOL WHITE 4,000K
If you want a bright and clean light, great for kitchens and workspaces then Cool White is the best choice

NATURAL LIGHT 5,000K
This colour light is crisp and refreshing making it ideal for reading and task lighting

DAY LIGHT 6,500K
Best in bathrooms, kitchens and basements; good for reading, intricate projects, or applying makeup

STEP 6

Where is this downlight going to go?

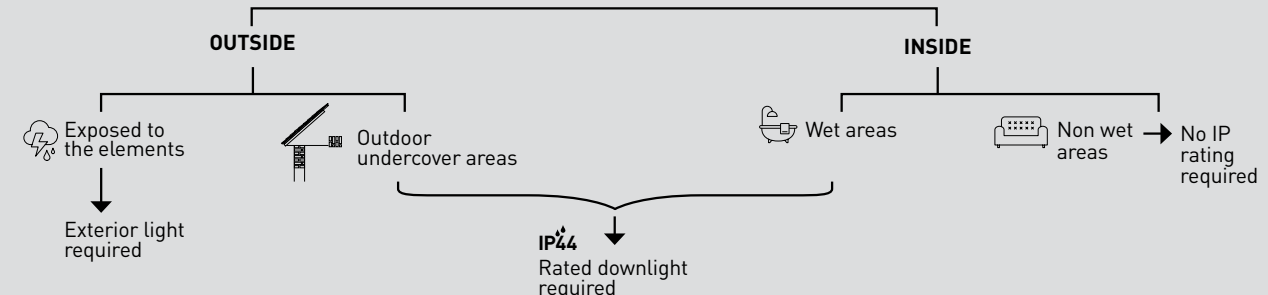

Linea - vertical switches 10A with 84mm mounting centres

Cat No. CDLN770/1

■ Dimensions

Cat No. CDLN770/1

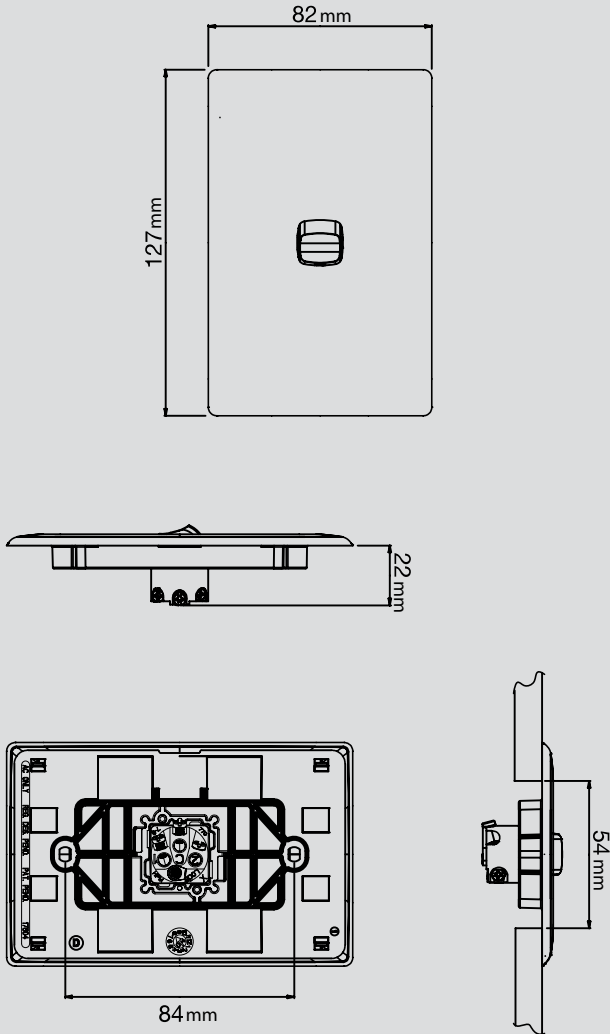

Linea - double powerpoints 10A with 84mm mounting centres

Cat No. CDLN777, CDLN777A

■ Dimensions

Cat No. CDLN777

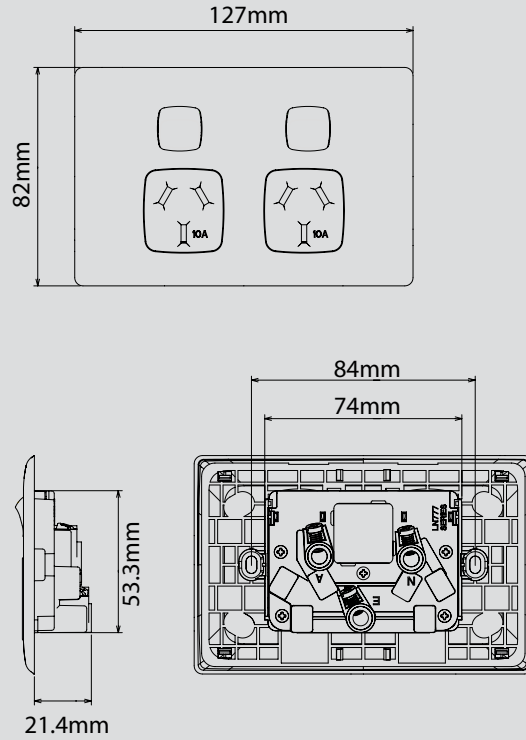

Cat No. CDLN777A (autoswitch)

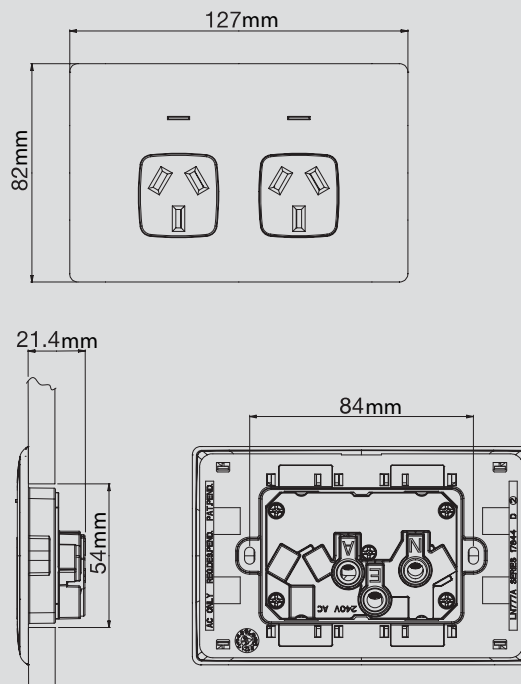

Excel - dimmers

Cat No. XL250L, XL250T, XL400L, XL400T

■ Specification table

Cat No.	Type	Maximum load	Minimum load	Incandescent	240V linear halogen	GU10 240V halogen downlights	Low voltage halogen with wirewound (Iron Core) transformers*	Low voltage halogen with electronic transformers	Ceiling fan
XL250L	Leading edge	250VA	10VA	✓	✓	✓	✓	✗	✗
XL250T	Trailing edge	250VA	10VA	✓	✓	✗	✗	✓	✗
XL400L	Leading edge	400VA	10VA	✓	✓	✓	✓	✗	✗
XL400T	Trailing edge	400VA	10VA	✓	✓	✗	✗	✓	✗

■ Note

Some electronic transformers state that they are compatible with Leading Edge Dimmers. However, significant derating of the dimmer is usually required. Therefore, HPM recommends the use of Trailing Edge Dimmers (HPM Cat No. XL250T, XL400T) for these applications. If it is necessary to use a Leading Edge Dimmer, then please refer to the Dimming Electronic Transformers information sheet enclosed with the product.

* When using wirewound transformers, ensure the transformers are marked "suitable for dimming" and derate the dimmer by 20%.

Excel - dimmers and fan controllers

Cat No. XL250L, XL250T, XL400L, XL400T, CDXL300F

Wiring diagrams

One-way switching with dimmer

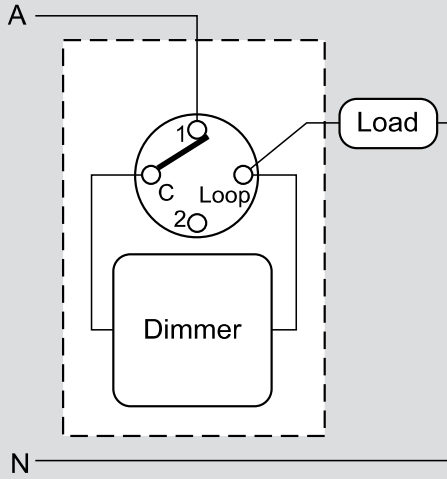

Two-way switching with dimmer

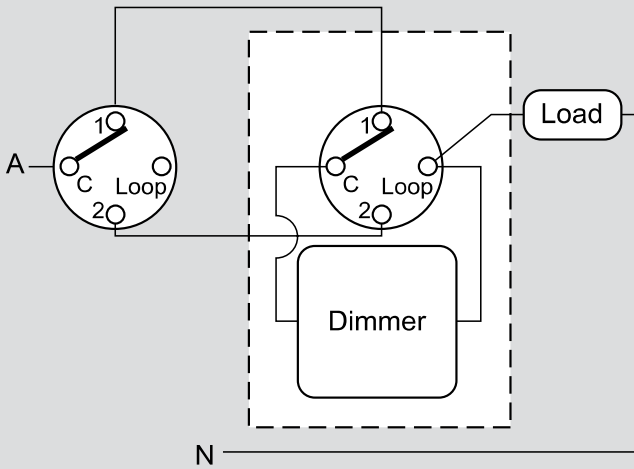

Dimensions

Cat No. CDXL300F

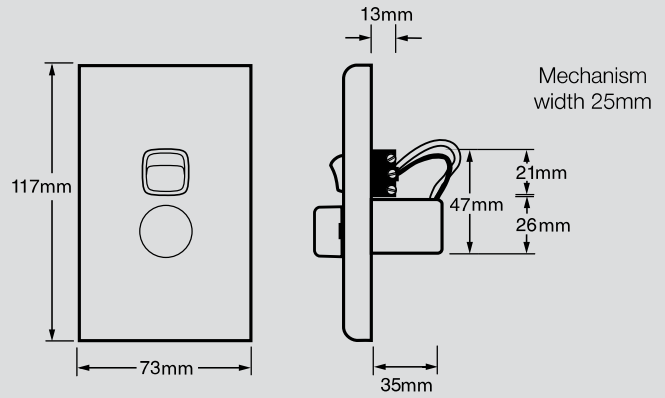

Cat Nos. XL250L, XL250T, XL400L, XL400T

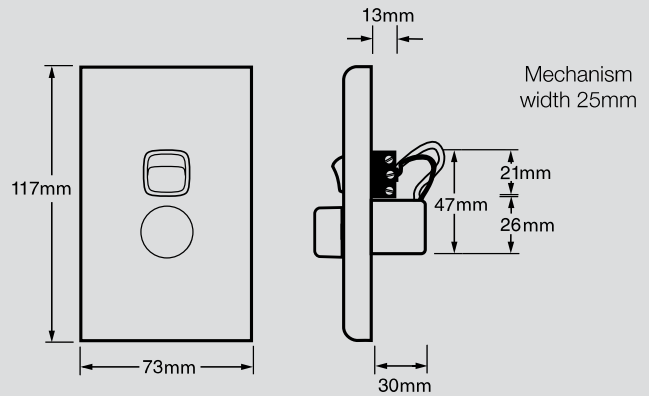

Excel - powerpoints with 84mm mounting centres

Cat No. CDXL787, CDXL787X, CDXLV787, CDXL777, CDXL777X, CDXLV777

■ Dimensions

Cat No. CDXL787

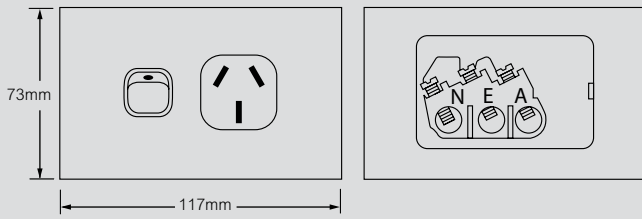

Cat No. CDXL777

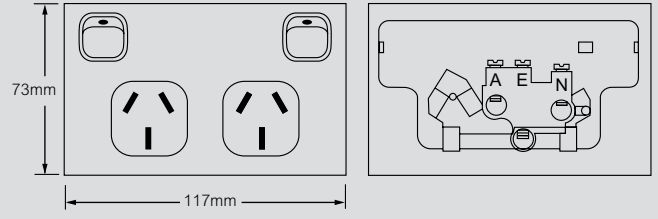

Cat No. CDXL787X

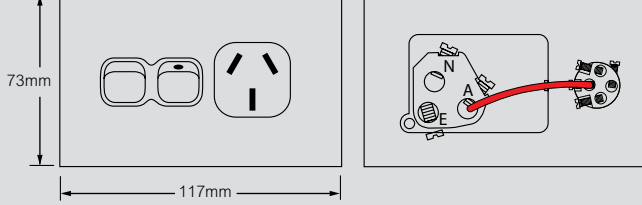

Cat No. CDXL777X

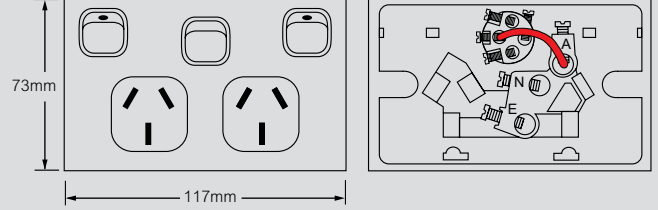

Cat No. CDXLV787

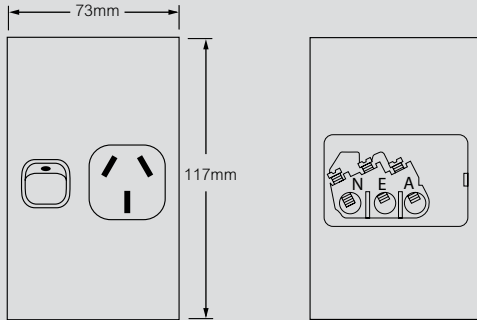

Cat No. CDXLV777

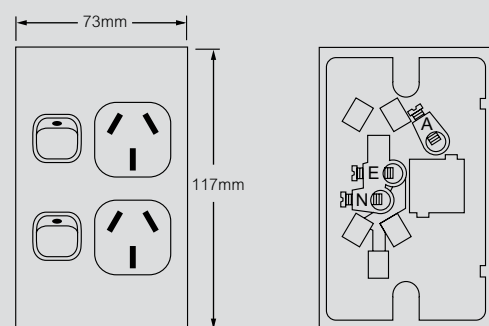

Standard powerpoints with 84mm mounting centres

Cat No. CD787, CD787X, CDV787, CD777, CD777X, CDV777

■ Mounting centres: 84mm

Cat No. CD787

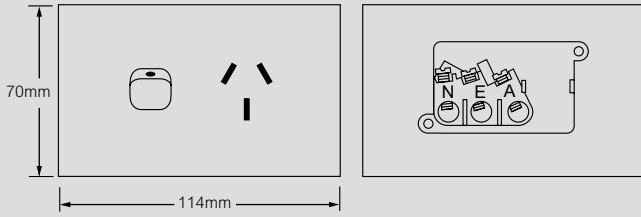

Cat No. CD787X

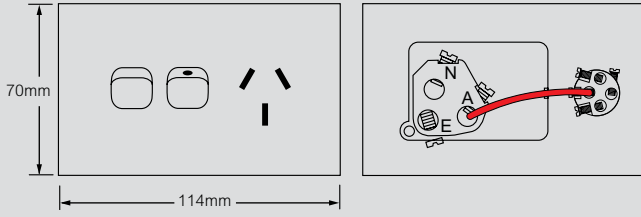

Cat No. CDV787

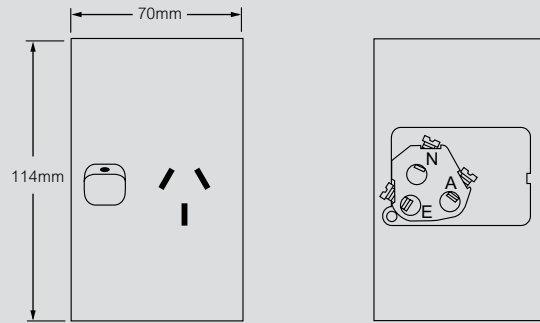

Cat No. CD777

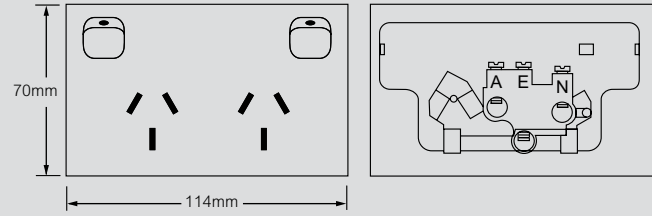

Cat No. CD777X

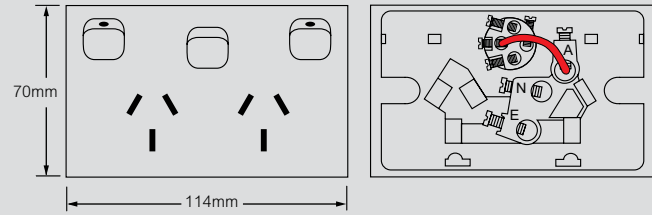

Cat No. CDV777

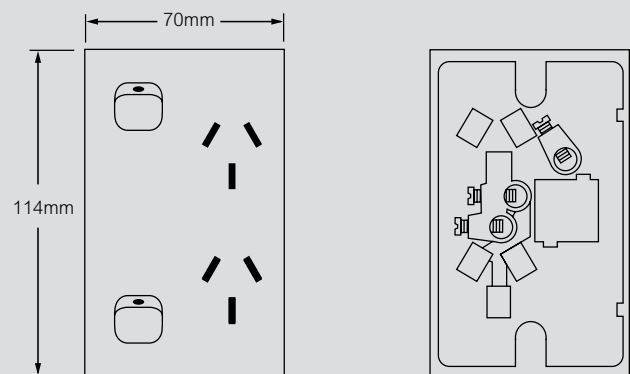

Standard - dimmers and fan controllers

Cat No. CD300FWE

Standard - powerpoints with 84mm and 137mm mounting centres

Cat No. 790

■ Dimensions

Cat No. 300F

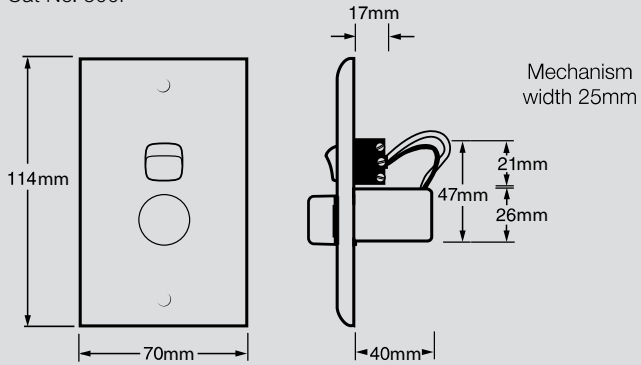

■ Mounting centres: 84mm

Cat No. 790

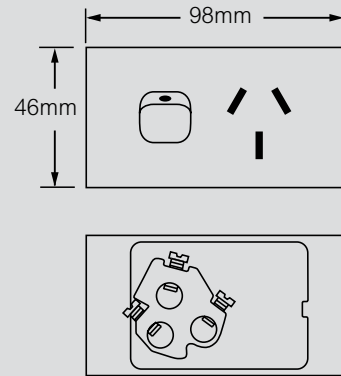

Ducted ceiling exhaust fan installation guidelines

Cat No. EFD01 series

Exhaust fan wiring rules

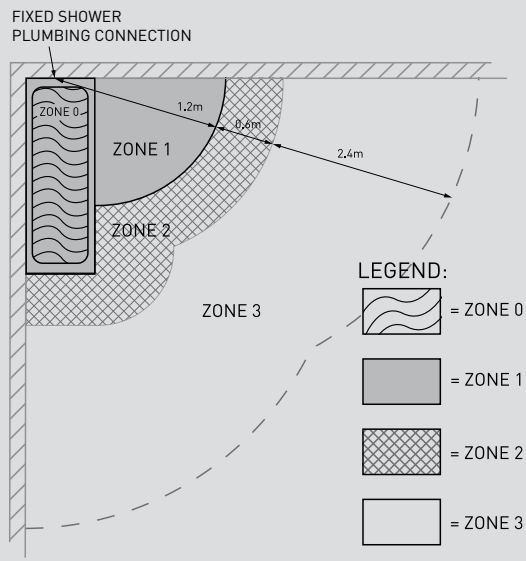
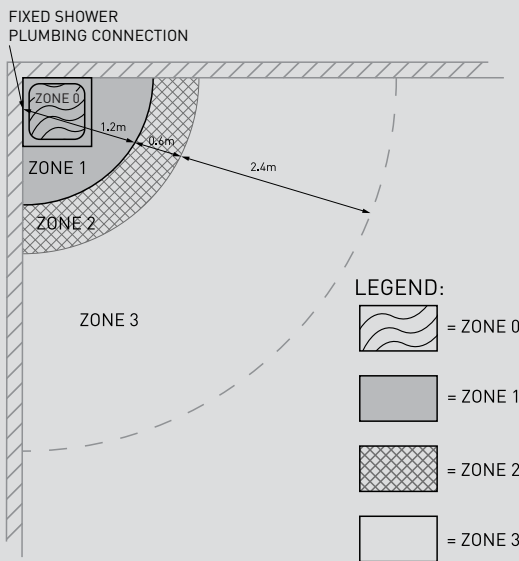

The EFD01 series shall be installed in accordance with the requirements relating to Section 6 Damp Situation of AS/NZS 3000:2007 Wiring Rules. No part of the unit may be located directly above any part of the bath or shower recess or enclosure. Please refer to diagrams: units must be installed within zones 2 and 3 only.

Exhaust fan correct installation:

1. Unit Orientation: the unit must be installed to ensure the housing outlet and ducting is oriented in parallel to any roofing structures or supports. Any 90° bend in the duct will cause performance reduction.
2. Duct Size: we recommend the unit to be installed with 150mm duct to ensure optimum extraction and performance.
3. Cross Ventilation: Air will only be exhausted if there is sufficient flow through the room. Ensure adequate air inlets exist through windows, vents or under the door.
4. Duct Outlet: Airflow will be reduced with pressure differentials between the room and outside air.

The duct outlet must be the same height or lower than the exhaust fan. The duct must not be installed vertically into a roof vent cap.

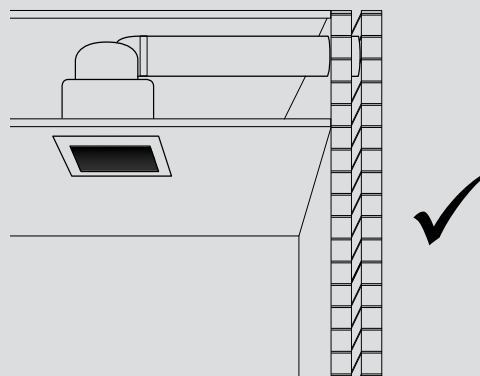
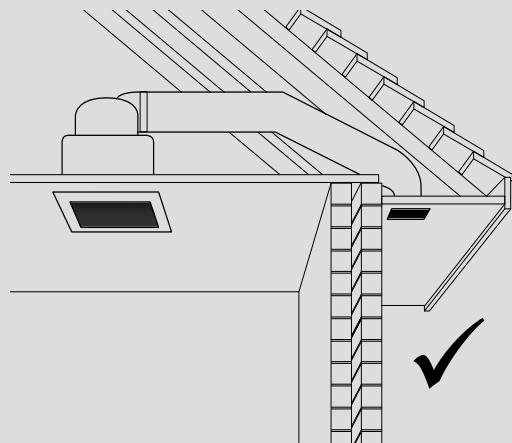

Time delay module for wall exhaust fans 100mm and 150mm

Cat no. EF100/150TD

Compatibility

EF100/150TD is suitable to be fitted on the following wall exhaust fans. Time delay module allows the fan to run for a set period, adjustable between 1 - 29 min, after the switch has been turned off.



EF100SQWE
EF150SQWE
EFS150SQWE



EF100SQSWE
EF150SQSWE
EFS150SQSWE



EF100RDWE
EF150RDWE

Fan mounting orientation

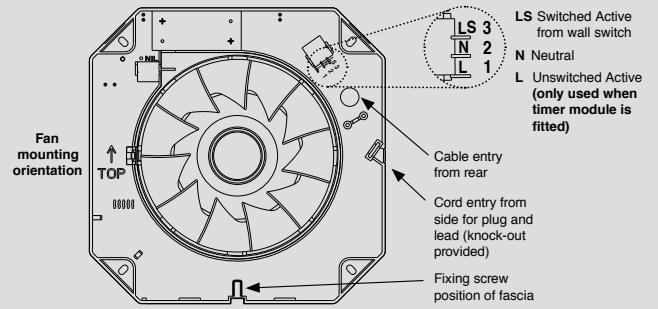

Fan with timer module and light fitting

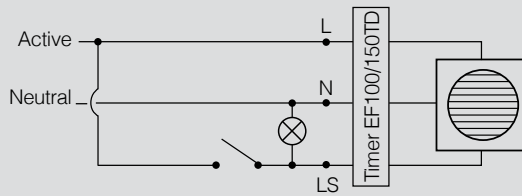

Connection from rear – bring mains wiring through cable entry hole.

Connection from side (Fan only) – use twin flat core (H03VV-H2) or circular core (H05VV-F) 2 x 0.75mm² and place under cable clamp provided.

HPM

The product partner you can TRUST



Whether you are buying, installing or using HPM products you can be assured they comply to all the required Australian and New Zealand standards of manufacturing quality and electrical safety.

HPM features in Prestons, NSW head office:

- local manufacturing of over 4,500 products
- a dedicated team and two accredited NATA laboratories to conduct compliance tests
- over 20 R&D engineers dedicated to the development of new products

All HPM compliance certifications and approvals are available on either the Electrical Regulatory Authorities Council certification database "erac.gov.au/public" or the NSW office of Fair Trading database "eapr.fairtrading.nsw.gov.au/default.aspx." For access to New Zealand Supplier Declarations of Conformity (SDoCs) please visit www.hpm.co.nz

A photograph of a dining room. In the foreground, a white square switch plate with a circular rocker switch is shown at an angle. The room features a wooden dining table with a light-colored top and legs, a wooden chair, and a grey chair. Three copper-colored pendant lights hang from the ceiling. A window with a grid pattern is visible in the background. A speech bubble is overlaid on the left side of the image.

I HAVE
ROSE GOLD
METALLIC
ACCENTS

I'M SLEEK & SQUARE,
SWITCH TO VIVO™



A brand of **legrand**

Legrand Australia

Building 4, Nexus Industry Park
43-47 Lyn Pde Prestons NSW 2170
1300 369 777
www.hpm.com.au

Legrand New Zealand

106-124 Target Road Glenfield
Auckland 0627 New Zealand
0800 476 009
www.hpm.co.nz

HPM is an active member of:

